



**extremis<sup>®</sup>**

[Go to  
index](#)





# Why on earth?

Why do we build new products? Is it just for the sake of launching a new product? Or is there a deeper rationale? At Extremis, we only start developing an idea if it is both necessary and useful. If it offers a solution. And makes you look at things differently. That is our absolute starting point.

[Go to  
index](#)

# Immortal ideas

From that point on, we take the Idea on a journey to create the best possible impact. Only the strongest ideas have the ability to ripple outward and span decades, not years. We aim to inspire the future by changing today's way of thinking.



Go to  
index





# Lasting materials

To maximize that impact, we employ only the highest quality materials and cutting-edge processes. To construct strong and durable products that sling that one, foundational idea into the future.

Go to  
index

# Carefully designed

The best way to make a product last, however, is to make it beautiful. In every aspect. To inspire both care and enjoyment. And become a focal point of the memories and experiences that make life itself truly beautiful.







[Go to  
index](#)



# With positive impact

That is the impact we strive to create. By transforming radical ideas into game-changing designs. Designs that are not only useful, durable and beautiful in themselves but also have the power to spark meaningful connections and enhance the way we interact with one another. A necessary condition for every Extremis design and the traces it leaves behind.



[Go to  
index](#)



We strive to create ideas that are loved for their personality, embraced for their quality, and cherished for their impact, as true **tools for togetherness**.

[Go to  
index](#)

EXTREMIS

**Traces**

ON

**to**

POSITIVE

**treasure**

IMPACT



### Gargantua

Page 66

The Gargantua table offers superior functionality thanks to its adjustable benches.



### Inumbr(in)a

Page 84

Its flat shape & high tension make it extremely windproof. Hi-tech: the most advanced fabric available.



### Pantagruel

Page 102

Meet the son of Gargantua. Featuring a 'Lazy Susan'.



### Abachus

Page 122

A high table with a little extra: when standing up, you can lean against one of its six arms.



### Anker

Page 132

A triangular picnic table that comfortably seats six of you Popeyes.





## Extempore

*Page 150*

A full range of modular outdoor furniture.



## Romeo & Juliet

*Page 166*

This bench adds a touch of green to your terrace or project.



## Hopper

*Page 174*

Boarding the Hopper stays easy, thanks to four pass-through zones on each table.



## Hopper shade

*Page 206*

Both opened and closed, Hopper Shade perfectly follows the lines of the Hopper table.



## Pontsūn

*Page 220*

Pontsūn is an extra wide table. Experience an oriental feel with the combination of robust wood and origami-like legs.



## Marina

Page 232

A picnic table in its most basic shape, offering lengths from 1.65m to 12.10m.



## Captain's chair

Page 258

Its wide shell offers the ultimate seating pleasure, even for big or tall people.



## Sticks

Page 278

A space divider and the perfect way to create privacy wherever needed.



## Picnik

Page 294

Table-seating combination made from half a plate of solid aluminium.



## Virus

Page 310

Virus, a playful picnic table for 2 / 3 / 4 / 5 people, brings life and dynamism to even the most sterile areas.



## Walrus

Page 330

The very first outdoor sofa. Blanket & comfort pillow can be stored in the backrest.



## Kosmos

Page 348

A table-seating combination with a lounging function.



## Kosmos parasol

Page 360

The Kosmos parasol opens and closes horizontally.



## Sol+Luna

Page 368

Take it easy in our Sol+Luna sofa sunbed, which transforms into a comfortable sofa at sunset.



## Icecube

Page 394

Simply the perfect cooler at all your parties, self-service!

# Extremis in a nutshell

Hello again! We are Extremis. We love 'stoverij' – a beef stew with beer – and French... um, Belgian fries.

**We're promoting a Burgundian yet responsible lifestyle.** Belgium is known as the land of culinary treats. At Extremis, we choose quality when it comes to food, and frankly, we should all do the same when we buy furniture as well.



**Belgian fries?** It is rumoured that 'French fries' received their name during World War One. At that time, English speaking soldiers were introduced to the fried potatoes in French-speaking Belgium, but because they thought they were in France, they labelled them 'French'.

This is our very first Gargantua, made in 1994  
(note the traces of wear).

**2010 First Hopper**  
By Dirk Wynants  
see page 174

**2015 First Anker**  
By Dirk Wynants  
see page 132

**2002 First Picnik**  
By Dirk Wynants & Xavier Lust  
see page 294

This is a **Gameboy** from  
the same decade. Only  
nostalgia is left.

At Extremis, design has always  
been about the whole cake.

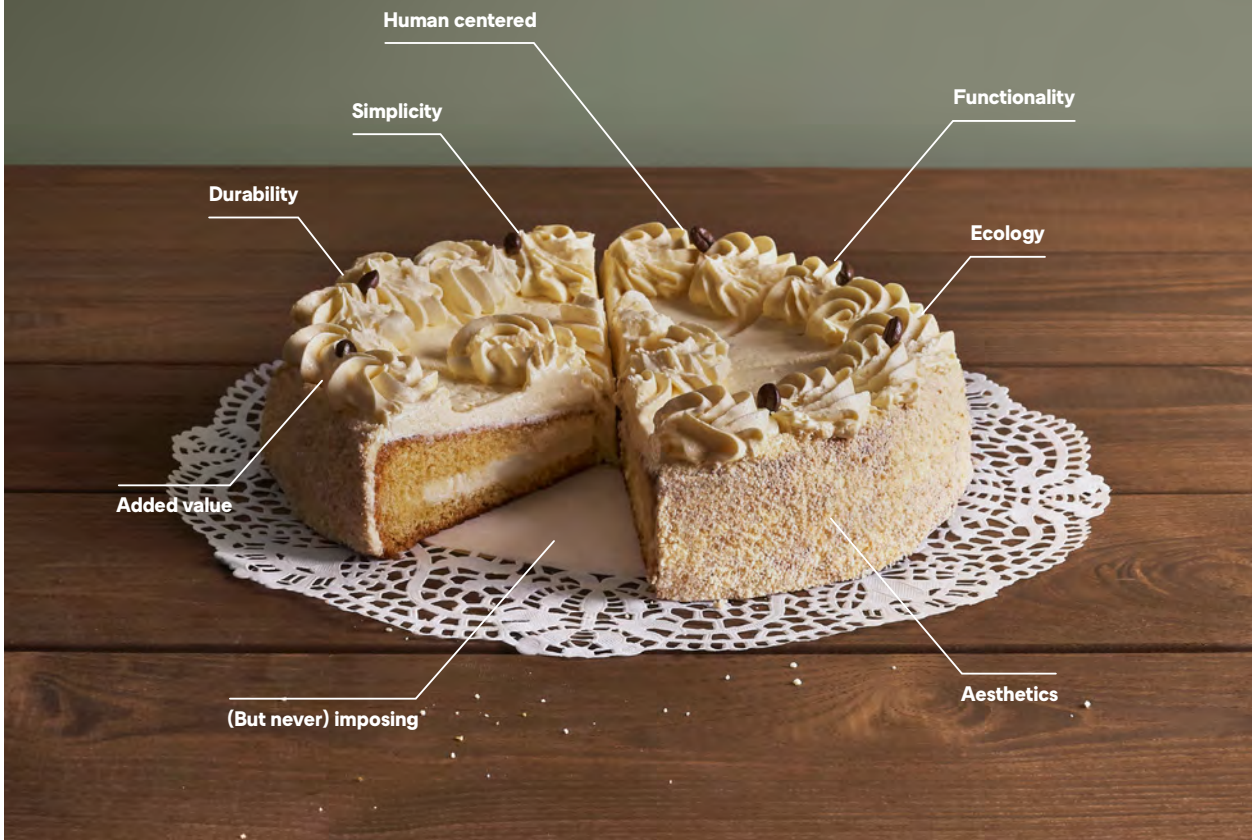

**Our many ecology awards**  
prove we're concerned about  
the world we live in.

**Plenty of design awards**  
certify the originality of our  
designs.

**More, management awards**  
say something about our  
ethical enterprise.

But in the end, we only seek recognition  
from you, our customers.

# Useful, necessary beauty

*Creating designs that last by inspiring  
interactions that matter*



An interview with Dirk Wynants

Some objects have the power to change our lives in ways we can never anticipate. They inspire new ways of looking at the world around us, and new ways of interacting with it. All of them began with a single idea – an idea that answers a basic need, and in so doing, sparks a journey that leads to game-changing designs. Dirk Wynants, founder and head designer at Extremis, talks about the true meaning of timeless design and what it takes to create objects whose traces are worth treasuring.





TECH  
WIND ME  
WIND ME

I We Flow

**Extremis was founded when the Gargantua was launched. But where did you get the idea for the design? What need did you perceive?**

Back then, our children were still small, and my wife and I enjoyed organising parties now and then. We particularly loved having barbecues outside in the summer and inviting friends and family over. Because the number of guests often varied, we wanted a certain amount of flexibility so that we didn't have to start dragging tables and chairs around. There was also the fact that it is better for children to sit in special, taller chairs so that they can talk to us. So, I designed the Gargantua, whose benches can be taken out and hooked back in at a different height - both higher and closer to the table - which was ideal for the children. If more people turn up, you fix the benches at table height and put chairs from indoors around them. At the same time, we wanted high-quality furniture that wouldn't need any special care. The resulting table brought together all these different functional decisions. That is how Gargantua was born, followed a little later by the Extremis brand. It was our search for perfect outdoor furniture that took us into the outdoor furnishing business. It wasn't so much because I was interested in it, but more because there was nothing on the market back then except for a few plastic chairs and teak furniture.

**Is that how the design process goes for all Extremis products?**

I suppose it is, because we always start with the realisation that something is lacking or that there is a demand that is not being met, or not met in the right way. Design happens as a consequence of the decisions we make. We don't design furniture on the basis of a specific aesthetic signature, which some designers do have. Our whole process works the other way round. We start out with a problem and look for solutions, and only then do we choose our materials - to serve





the needs of the design. We don't say: let's design a chair. No, instead we will start thinking about how we can bring people together. And if the result is beautiful, that will be more of a coincidence than anything else. Of course, beauty is also one of the functions I give to a piece of furniture. So, if we have come up with a solution that is painful to look at, we go back to the drawing board. Because ultimately, of course, the point is to surround ourselves with beautiful things, items that are justified by their beauty. Just seeing them should make you happy. But the combination of all the product details forms the logbook of the journey our design has made in its development phase.

#### **What do you want to achieve with Extremis?**

Well, as a designer I don't think there is a huge amount we can do to change the world. We don't have the same impact as someone who is trying to find a cure for cancer, for example. But I do think we can make an important contribution to people's quality of life. That is a focal point for us at Extremis. Making things that improve the quality of life: things that make people happy. We want to do that while causing as little damage as possible. To be honest, I often find myself complaining that there is too much on the market. And what do I do as a designer? Put even more things on the market? A design needs to make sense, to really make a difference. I believe we need to be really critical about that.

If the design doesn't really improve on anything in the designs that already exists, it is simply dead weight. You need to have a reason for the things you do. You shouldn't do things just to increase a company's turnover or earn a bit more money. I believe that things have to be useful to society. We set the bar very high.



Every product you make has a certain impact. So, we have to try and make that impact as positive as possible. That has to do with keeping transport to a minimum, using materials efficiently, considering the lifespan of those materials and also the lifespan of the design and the ideas themselves.

**What role does sustainability play in your work?**

I often notice that when people talk about sustainability or ecology, the conversation soon turns to the use of recycled materials or cradle-to-cradle. Of course, those are really important issues. But what is most important to me is coming up with an idea that will stay

---

We don't draw our inspiration from design magazines or from looking at other furniture: we look around to see what is changing in the world outside.

---



relevant for a long time. You can think about recycling and all sorts of ecological materials, but if your design only has a lifespan of three to five years, you can never call it sustainable.

The Gargantua came onto the market in 1994, for example. As recently as 2014, it was selected for the terraces of The Interlace in Singapore. That is a gigantic residential complex that was voted best building in the world in 2015. 20 years after its launch, the Gargantua is still just as easy to incorporate into other concepts! That is our goal. We try to create the classics of the future. You never know in advance whether something is going to be a classic. But you can at least try to design things with the potential to become one. I do believe we have managed to do

that several times. Whereas products usually have a lifespan of three to five years, it is only after that period that our products start to become commercially viable. And then, if they keep on selling well many years later, I believe that is a fantastic achievement.

**Where do you see Extremis in the history of furniture design?**

We are quietly confident that these products will become part of an evolution that has been happening all along. We know what furniture the Egyptians had, or the Romans, and later what they had in the Middle Ages and certainly in the time of the French Kings,

Louis XV and so on. In all those periods, certain designs were part of that culture, that era. And I hope that – if people ever look back on our time – our furniture will feature in there somewhere as one of the elements on which the future was built.

Within our range, we also continue to build on earlier designs. 20 years after the Gargantua, we believed the time was right to design its son, the Pantagruel. It looks a lot like its father in many ways, but the emphasis is different. The fact that it was so easy to sit down on the Gargantua, without having to swing your legs over the bench, was the biggest improvement on the standard picnic bench and a game-changer at the time. We have reused that idea in other designs in our range.

---

An idea is only as good as its ability to go beyond itself. To transform the ways we live and interact with each other. For the better.

---

**What do you believe has changed most since Extremis was founded in 1994? And how has Extremis reacted to those changes – changes in society, for example?**

We don't draw our inspiration from design magazines or from looking at other furniture: we look around to see what is changing in the world outside. There have been huge changes in recent years, and people's needs are changing, too. That is something we try to keep track of as closely as possible – to use that as the basis for new designs or new areas in which it makes sense to design new things.

Take the change of mentality in favour of living in smaller homes, after a century in which houses became ever larger and more ostentatious. For people in the city with less space to spare, we launched the Picnik 15 years ago, and more recently the Virus as well. You don't find inspiring social trends like those in a design magazine.



**Hopper**  
[2010]



**Anker**  
[2015]



**Abachus**  
[2009]



**Pantagruel**  
[2014]



**Gargantua**  
[1994]



**Picnik**  
[2002]



**Virus**  
[2016]

A table like Gargantua made people look at outdoor furniture differently.

Its impact rippled outward and inspired us (and others) to design new solutions. That's what we aim for with every new design.



[Back to index](#)

# Designing for density

Space is priceless. Every square centimetre counts, especially in a world where 60% of the earth's population will be living in ever more densely populated cities by the year 2050. With greater proximity, however, comes more intense interaction. This fact forms both the start and endpoint for Extremis designs, whose very *raison d'être* are defined by concrete needs.



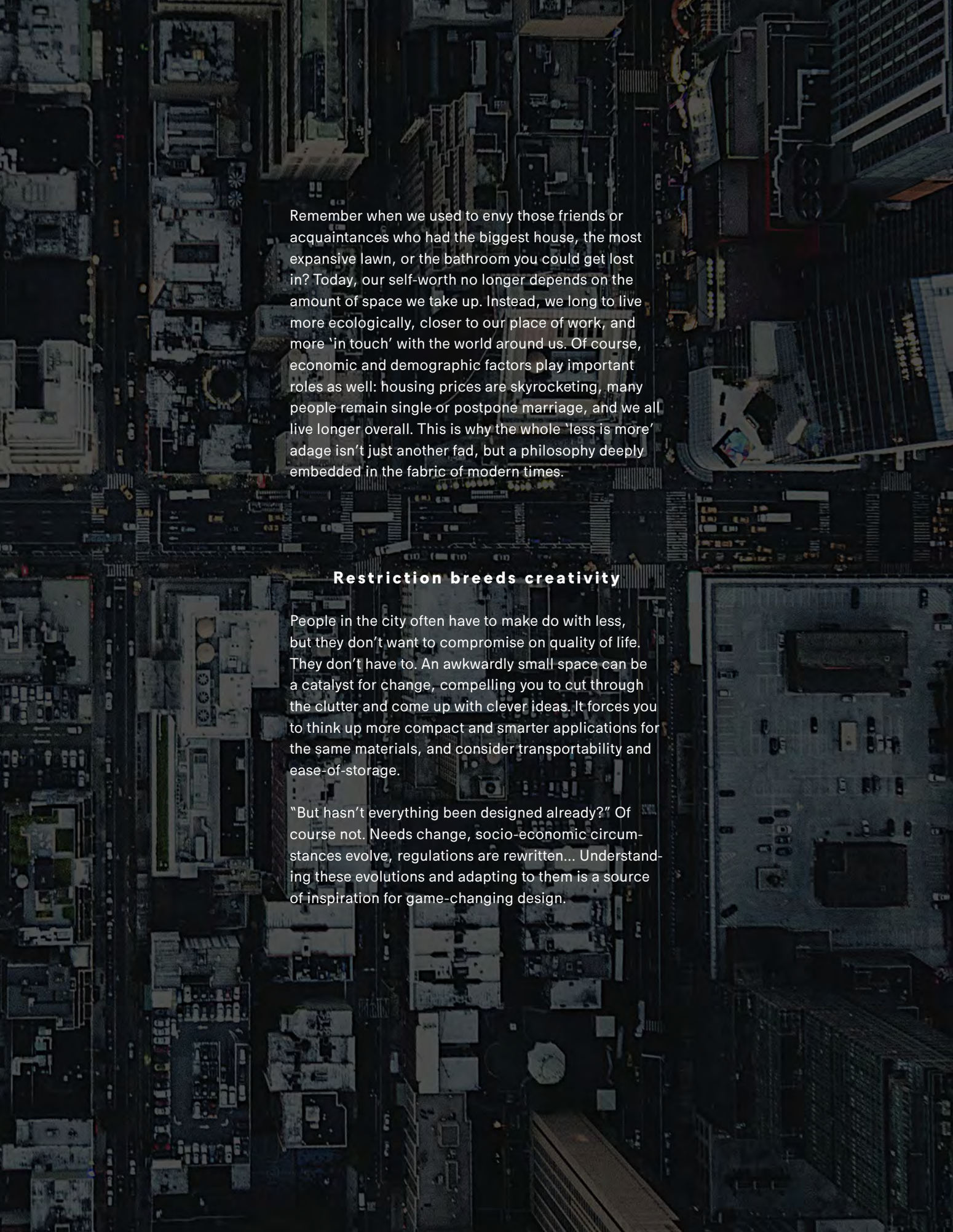

Remember when we used to envy those friends or acquaintances who had the biggest house, the most expansive lawn, or the bathroom you could get lost in? Today, our self-worth no longer depends on the amount of space we take up. Instead, we long to live more ecologically, closer to our place of work, and more 'in touch' with the world around us. Of course, economic and demographic factors play important roles as well: housing prices are skyrocketing, many people remain single or postpone marriage, and we all live longer overall. This is why the whole 'less is more' adage isn't just another fad, but a philosophy deeply embedded in the fabric of modern times.

### **Restriction breeds creativity**

People in the city often have to make do with less, but they don't want to compromise on quality of life. They don't have to. An awkwardly small space can be a catalyst for change, compelling you to cut through the clutter and come up with clever ideas. It forces you to think up more compact and smarter applications for the same materials, and consider transportability and ease-of-storage.

"But hasn't everything been designed already?" Of course not. Needs change, socio-economic circumstances evolve, regulations are rewritten... Understanding these evolutions and adapting to them is a source of inspiration for game-changing design.

## Good design is contagious

It is also our main source of inspiration at Extremis. It's why people come to us after a product presentation to express their disbelief: "Why hasn't anyone thought of this before?" Our main goal, however, is always to encourage togetherness. A baby shower in a small urban garden or an after work party on the balcony? For Extremis, all types of gatherings can inspire new designs, as long as there is a practical need that can be met, or if usability can be significantly improved.



---

Spaces are not just meant to be  
filled. They should be lived.

---

When Dirk Wynants saw the junk piled up on the balconies of even the most luxurious lofts and penthouses, he realised the need for small and compact tools for togetherness. The result, the Picnik table, is perfectly adapted to a confined environment and to today's most common family unit: the couple. This seminal creation sparked other innovative creations that not only respond to specific practical needs, but inspire new ways of living and interacting with one another. Such as the playful and space-conscious Virus table, or the equally efficient hexagonal Anker.



## Gargantua

This page seats  
88 people

---

Gargantua was originally created with  
the rural spaciousness in mind.

[Back to  
index](#)

## Anker

This page seats  
112 people

---

Anker is our answer to a growing need  
for optimal use of space.

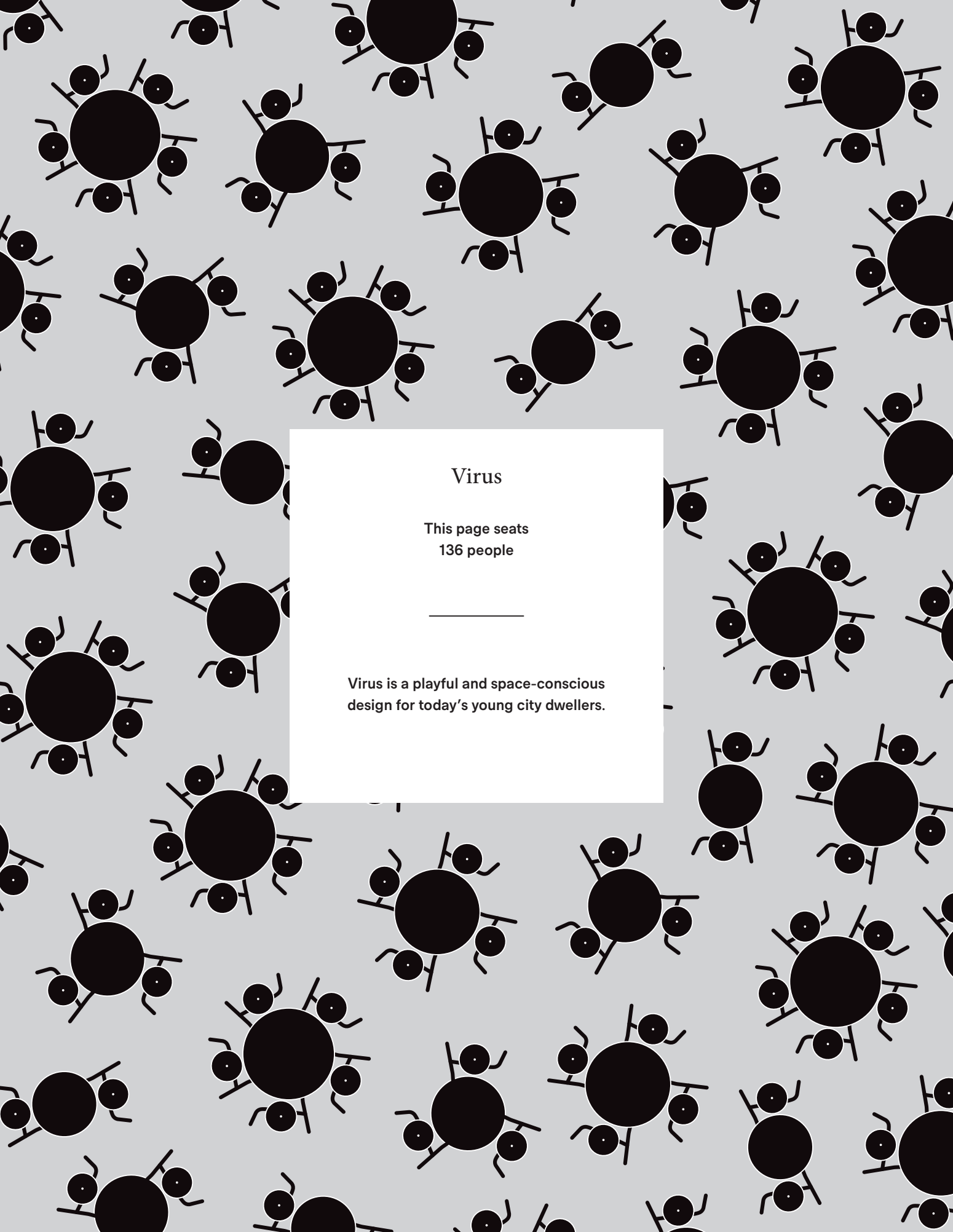

## Virus

This page seats  
136 people

---

Virus is a playful and space-conscious  
design for today's young city dwellers.

Back to  
index

**What you see  
is not what you  
get...**

Extremis



Trick question: where can you find most outdoor furniture? Exactly: outdoors. This means that your new chair, table or bench will change with time. It also means that our designers focus on creating furniture that looks stunning for a lifetime, and predict how its appearance will evolve.

At Extremis, we believe that true beauty should be capable of withstanding the rigours of time and exposure to the elements. Not to mention the fact that you probably have better things to do with your time than cleaning and maintenance. That's why durability is built into the aesthetics of each and every creation. The results are authentic tools for togetherness that last generations.

Making furniture that lasts starts with choosing the right materials, like wood and galvanised steel.

---

More often than not, enjoying your furniture for a long time, starts with choosing the right materials. Some thoughts on our two favourite materials.

---

### **Our wood is alive**

Wood is a living material. In spite of the superior quality provided by the species we use, it constantly adapts to changes in temperature and humidity. In the same way your teeth won't stay white without brushing, wood won't remain perfectly smooth without any maintenance. Exposure to sun and rain will gradually change its colour to silvery grey, and roughen the surface.

When delivered, the wooden parts of our products are untreated. Exposure to sun and rain will gradually change their colour to silvery grey, and also roughen the surface. We strongly recommend that you treat your wood regularly with wood oil to protect it from stains and to slow down the roughening process. Along with these downsides, our wood comes with great characteristics: the production of wooden parts consumes 60 times less energy than steel parts, it's extremely durable - by sanding and oiling regularly, our tables easily reach the age of 20, you can barely see when there's surface dust or dirt, and the wood looks warm and feels comfortable.





**BRAND  
NEW**



**AFTER LOTS OF  
RAIN & SUN**

Positive impact

Back to  
index

**BRAND  
NEW**

**AFTER LOTS OF  
RAIN & SUN**

Extremis

## **Hot dip galvanizing: the George Clooney of coating techniques**

Freshly galvanized steel has a very shiny appearance. Over time and when exposed to the elements, however, it gradually turns matte. This means it's great at camouflaging dirt, and looks better with age – just like George Clooney. Combined with the aging, greying wood, it gives your entire table a smooth, silver-grey and timeless appearance. We still get compliments from satisfied customers whose tables have been standing outside for over 23 years. To this day, galvanized steel remains our second most-used material.

The specific process we use even received the Cardle2Cradle certificate of the Products Innovation Institute (US). And while galvanisation is an energy-intensive process, the extreme durability and recyclability of the steel more than makes up for this.

Most of our range adapts perfectly to any kind of weather. However, there are some dos and don'ts when choosing the right tools for togetherness. Only choose white if you are willing to be more careful and clean regularly. Even still, you should bear in mind that nothing stays bright white outdoors.

## **Durability rhymes with usability**

Extreme durability is at the core of every materials-based decision we make at Extremis. While the average lifespan of consumer products is dropping below 5 years, our goal is to set a new standard by doing the exact opposite. In our view, the most ecological product doesn't have to be discarded or even recycled.

Apart from choosing durable materials, we also ensure that our products can be easily maintained and – if necessary – repaired. Local damage shouldn't spoil the fun, and disassembly shouldn't require advanced tools. In this way, torn parasol clothing or a cracked plank can be fixed in no time.



Positive impact

# The colour of authenticity

*Colours capable of inspiring without  
imposing, offering a blank canvas for  
the art of living.*

Extremis

Our tireless search for purity and honesty has resulted in a colour palette inspired by the furthest reaches of the globe. Starting from the elemental transparency of matte monochromes contrasted with brushed finishes in shades of white and grey... to the warmer tints and textures of terracotta and natural nuances in green... and the unmistakably feminine inspiration of cool, sculptural tints...



Extremis' products don't need to shout. We want our furniture to attract people while blending seamlessly with any setting. Natural materials like wood or anodised aluminium do that. So do the right colours. Our colour professionals define the right colour range in combination with our basic, pure materials. While there's an expected colour palette when it comes to outdoor furniture, our tools for togetherness are also used indoors — in meeting rooms, kitchens, etc. This made creating a compact yet complete selection quite a challenge. Our new range follows three different colour concepts or attitudes, which you can discover on the next pages.

---

These concepts, however, are based on the following aspects of colour selection:

---

**Choose colours that stand the test of time**

Our tools are designed to last longer. That's why our bigger, most important products don't contain any trendy colour schemes. After all, you want a colour that can stand the test of time, and that won't immediately feel dated. Neutral colours are often combined with wood. The wood will reveal its true personality after a while, as it starts to fade and turn silvery grey when exposed to sun and rain. Trendy colours should be added as a decorative element, for example as a cushion or something that can be replaced from time to time. You can explore them in our fabric range.

---

Our colours attempt to strike that delicate balance between presence and absence. They should speak to us, in other words, while at the same time silently fading into the background.

---

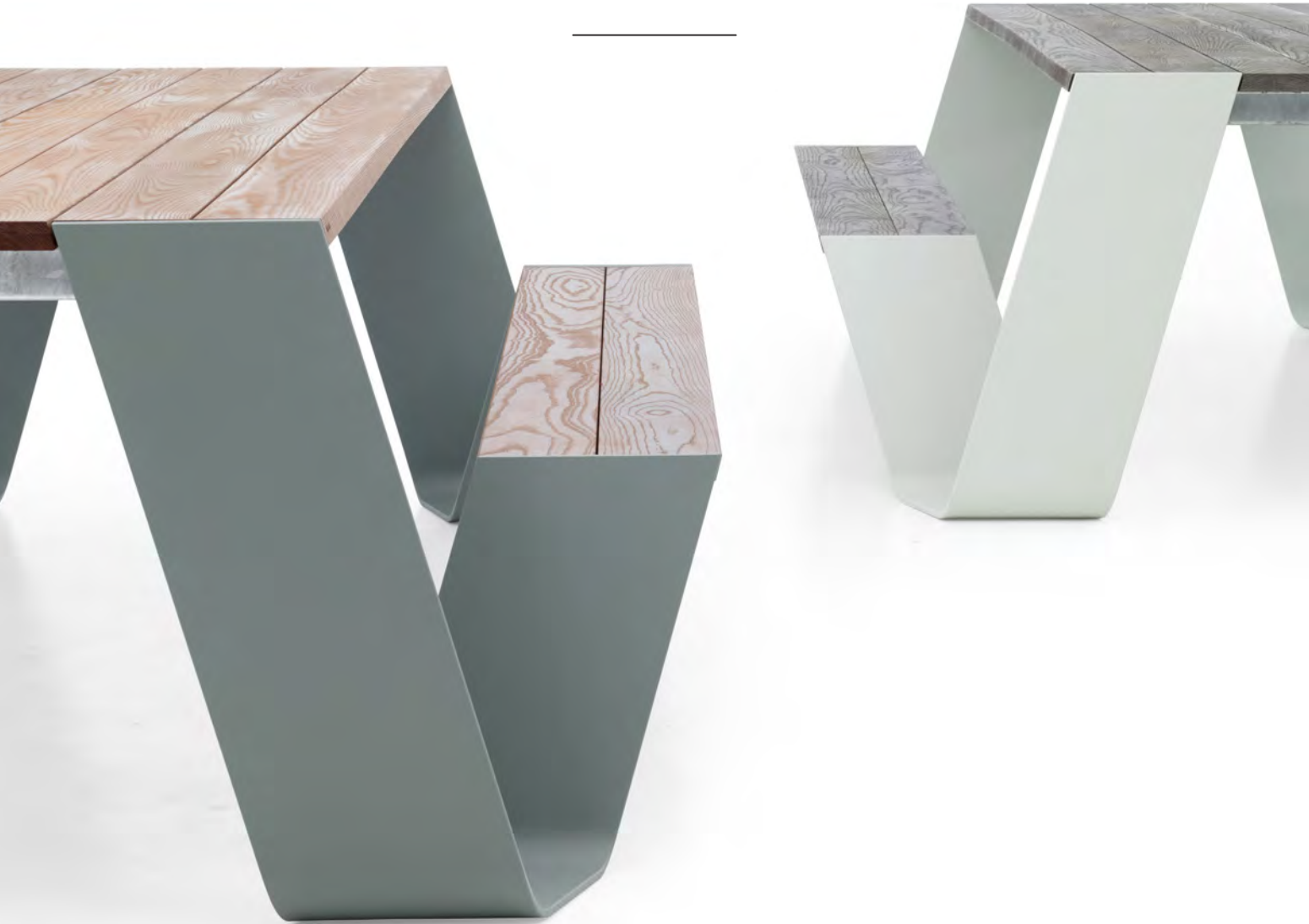



### **Choose colours that minimize maintenance**

Materials should require as little maintenance as possible. That's why we design and choose materials with the laziest person in mind. Within our range, however, some colours are high maintenance, and some aren't. A white Hopper leg needs more cleaning than a black one. It is as simple as that. We added some earthy, natural colours to our range to offer more maintenance-friendly options.



### **Choose colours that make it pop or make it blend**

Choose products that match the surrounding architecture, and colours that match the surrounding colour palette. Have them set the tone while silently fading into the background, outdoors and indoors.

### **Choose colours according to your climate**

For a large part, colours determine the temperature of a piece of furniture. Darker colours will absorb the sunlight and heat up in the sun. For some climates, this could be an advantage, but in warmer regions, lighter colours will be more appropriate. A rainy and humid climate will also affect your choice of colour - or at least, it should!

Extremis







# Our colour concepts

1.

## The essence concept

---

**The essence of design; that's what this theme is about.** It is inspired by architecture, which protects us and provides a haven for the hustle and bustle of everyday life. Furniture is a form of micro architecture, a warm cocoon where we spend time with friends and family.

Just like a tool, Extremis furniture performs in silence and humility: it gathers people together, lets them relax and brings them closer to nature while the thing itself disappears into the background. The design, the colours and the materials are pure and timeless. But there is no doubt: although it is not always visible, this is indeed cutting-edge industrial design with a high-tech side. This theme fits into the most diverse architectural styles.

The materials are fair and are often not covered, showing their bare construction and functional beauty. They maintain their natural quality, like weathered wood, for example. Matte monochromes are combined with brushed or lightly structured finishes. The colours are inspired by architectural materials such as concrete and, on the other hand, the colours of the element air. It is a range of white and grey tones, with cooler and warmer variations.

Our big pieces of furniture always feature timeless, architectural tones that make it blend with its surroundings. By simply adding some textiles in a strong primary colour they turn into veritable eye-catchers. Applying bright-coloured details is also perfect to make smaller design pieces stand out. We love the mix of bold colours, from furniture to furniture fabrics, right down to the smallest cushion.





### 3. Touch concept

---

**The touch concept combines hard materials with subtle finishes and round shapes.** The result is an exquisite, soft character. High-tech objects are also shaped in this way, making them part of a comfortable and elegant residential landscape. Furniture becomes almost sculptural. As boundaries fade, these colours add an indoor feel to outdoor spaces, and a homely feel to office spaces. The solid and sturdy materials are treated with matte powder coating that gives a soft, tactile shine. The colours radiate femininity – in a combination of nude tones – but also borrow from the visual arts for an intellectual, artsy touch.



Extremip

# Crossing borders

*Blurring the lines between work and  
play, inside and out, now and in the  
future.*



Limits only exist in the mind. At Extremis, we are committed to going beyond limits by creating objects that challenge prevailing assumptions about form and function. Objects that exceed the accepted lifespans of their counterparts. Objects that literally extend the boundaries of your home and, ultimately, objects that break down the barriers between people, inspiring new ways to live and interact together.



Marina table as a desk and Marina combo at Dirk Wynants' office and home. A farm renovation project by Govaert & Vanhoutte and Dirk himself.

### **Indoor vs. outdoor**

The name 'Extremis' is a free translation of 'out of the ordinary' into Latin. 'Out' because all our products were primarily designed to be used outdoors. 'Ordinary' because they exude humbleness and serve their users rather than stealing the show themselves. Because Extremis products are designed in this particular way, they are perfectly suited to cross the boundary between indoors and outdoors.

In fact, Extremis has always defied the notion that outdoor furniture can only be used outdoors. In 1994, when we just started, the outdoor design market was still in its infancy. Design furniture was only used indoors. Today, this imaginary boundary has almost completely disappeared. As is clear from our current product range, the interior is becoming an extension of the garden and vice versa.

→

Pantagruel and Inumbra at Alheembouw headquarters by B2Ai.

---

The first condition for us to start designing anything – and we can't stress this enough – is that it solves a practical problem or improves a specific situation.

---

### **Ordinary vs. extraordinary**

Our tools for togetherness also have that extra something. That's because we look at things differently. Form follows function: we solve practical problems or improve existing situations by 'rethinking the box'. This is why, from an aesthetic point of view, Extremis products aren't afraid to be edgy, to contain a certain twist. 'Strange looking but well-functioning' is probably the most common feedback we get from colleagues in the course of a new design project. It's that *je ne sais quoi* that makes our products cross the threshold between the 'ordinary' and the 'extraordinary'.

In this way, we also find an equilibrium between the familiar and the forward-thinking. We design for the future, but keep our users' worldviews firmly in mind. We position ourselves right on the brink between the conflicting forces of safety and excitement. The end result is always something familiar, yet surprising. Something undeniably innovative, yet acceptable. As a result of this balance, Extremis' furniture is always ahead of its time. A new product is aimed at early adopters, but in time, finds its way to a broader audience.



## Work vs. play

Another boundary we've constantly ignored through our 20-year history is the one between work and play. Office spaces with a homey feel are en vogue right now, as are 'breakout spaces'. These designated areas offer employees a space for collaboration, informal meetings, or just a refreshing alternative to their familiar workplace. It's important that breakout spaces are different from the heads-down workspace. Choosing the right furniture can play an important role in this.

This workplace evolution has been enthusiastically embraced by frontrunners like Google and Apple - both Extremis fans. Google even converted the idea into concrete workplace guidelines, and turned workplace design into a science in itself. It's a way to 'optimise people', both in terms of happiness and performance. There are even instructions for the lunch tables: if you want employees to meet each other, the tables should be long. This will expose them to more people who they can get to know. They also found that diner booths boost creativity more than conference rooms. The goal is to facilitate 'casual collisions' through interior design. After all, as Google's Vice President of Real Estate and Workplace Service David Radcliffe says: "You can't schedule innovation or idea generation."

Positive impact

---

Google turned workplace design into a science in itself, as a way to 'optimise people', both in terms of happiness and performance.

---

[Back to index](#)



Extremis



## **How the Herman Teirlinck building breaks boundaries**

With a surface area of 66,500 m<sup>2</sup>, the Herman Teirlinck building on the Tour & Taxis site in Brussels is the largest passive building in Belgium. The beating heart of the building is a covered, indoor street. Here, all common functions shared by staff and visitors — such as a central information desk, restaurant, reception rooms, auditoriums, exhibition space and meeting centres — are located.

The street also provides access to four large winter gardens, which provide daylight to the floors above and are not climate controlled. In this way, they effectively bridge the gap between inside and outside. Strategically placed in the gardens alongside the vegetation are a number of Extremis' Hopper tables and benches to create the perfect place to take a break from work and relax. In a few years' time, those courtyards will provide five-meter-high green oases: multifunctional spaces where workers and visitors can escape the daily hustle and bustle and reflect.

In total, the Herman Teirlinck building provides 1,800 flexible workplaces for 2,600 people. Not only is this in line with the rising teleworking trend, it also means that employees are free to choose the spot in the office that is best suited to their current task. Every workplace is a generous 20 square meters. Ample working space, and the availability of breakout spaces in the form of four courtyards, provide the ideal environment to strike a balance between relaxation and productivity.



The Herman Teirlinck building by Neutelings Riedijk Architects features a Hopper combo in one of the winter gardens, designed by Avantgarden.

# Looking for paradise

*Thomas D'hooghe's  
quest for Utopia*

With his Pop-up Hotel initiative, digital entrepreneur Thomas D'hooghe wants to create spaces to slow down, to stop and smell the proverbial roses. Last summer, he set up camp in the Bulskampveld in Bruges with a number of 'tiny houses'. These 15-m2 living spaces each contain a compost toilet, a shower, a kitchen, two seating areas, a two-person bed, storage space and sometimes even a rooftop terrace. In short, they perfectly combine sustainability with optimum use of space. Furthermore, each tiny house was accompanied by one of our tools for togetherness. Needless to say, we had to have a talk with him.



Positive Impact

Back to  
index

---

One of the little things in life that  
doesn't cost anything is having  
breakfast together and a good  
conversation.

---



**How did you put the idea into practice?**

The essence of The Pop-Up Hotel and Paradise is slowing down and adapting to the pace of nature. To attract a wide audience, we decided to go for the more stylish concept of glamping. There is no point trying to get 50-year-olds into a tent. And ultimately, we want to link it to an experience that people react to along the lines of "damn, I've never done anything like that before".

**How did the idea for The Pop-Up Hotel come about?**

A few years ago, I felt like the ground was shifting beneath my feet. I had been suffering from depression for a year, and that year had taught me to enjoy the little things in life. Things that didn't cost anything but were extremely valuable, like playing with the kids, walking in the countryside, gathering around the campfire, looking up at the stars, etc. In the following year, I drew up a business plan that went as follows: buy a plot of woodland, set up some fun places to stay and invite people in a similar situation to come and slow down for a while and learn to enjoy life again. That is a serious business model, too big to put into practice all at once. So, we launched an experiment last year called 'The Pop-Up Hotel'. People could book a stay at the hotel for two months. It was a test for the definitive plan: Paradise.

That vision was already clear in December 2016, but it is only thanks to the volunteers, who turned up at various times in those six months, that the project really began to take shape: quality mattresses for a really good night's sleep, tiny houses that didn't compromise on comfort, and a pleasant cooking experience thanks to Barbecue and Greenpan. I suppose you could let people sit on carved wooden benches, but the use of Extremis furniture took the experience to a much higher level. I am extremely grateful for that. The combination of nature and Extremis furniture was a revelation. It was fantastic. The photos show what I mean. Extremis products also fit perfectly into our concept. It is not just the style that sparks the imagination; products are well-thought-out and ergonomic. But the thing I was looking for right from the start was to make sure everything had something to do with sustainability, and to work with organisations that used sustainable products. That was a clear link to Extremis in itself. Another link is Extremis' value of 'togetherness'. One of the little things in life that doesn't cost anything is having breakfast together and a good conversation. Of course, those values correspond perfectly with the philosophy of The Pop-Up Hotel. It was a no-brainer.

### **What does togetherness mean to you?**

Simply having breakfast together in the morning. You can't be more together than that. We had a really delicious, affordable breakfast at The Pop-Up Hotel. The guests always ate their breakfast outside under parasols that don't let a single drop of rain fall on their food. But people spent a lot of time playing board games too, for example, and all of it happened around the same table. Every tiny house had its own infrastructure: its own Extremis Anker picnic table and a barbecue. But we also had a kind of plaza with a sauna barrel. That was where the long togetherness picnic table Marina was, and if people from different houses wanted to hang out together, they used the Marina. That created another connection between the various different tiny houses.

### **What effect has a stay in The Pop-Up Hotel had on guests, do you think?**

We had a guestbook in the hotel, and I urged everyone to fill it in honestly so that we could use their feedback to find out what we needed to improve. But seriously, that guestbook has warmed my heart so many times. People did exactly what I hoped they would do. They enjoyed each other's company, lingered over breakfast, played games, read books, walked, cycled and stayed away from their mobile phones for a while. Digital detox was a very important component of The Pop-Up Hotel for me, and that really was what people did. Everyone felt – and lived – close to nature.

I believe that our society is far from peaceful. The rat race, the 'stress-is-a-drug' society... I'm not even the one who came up with those terms. People are expected to be in touch and available around the clock. On social media, by e-mail, messenger, phone. If you want to succeed in your aim of simply getting people to calm down, the first thing you need to do is take all those stimuli away. That is why there was no television, either. We really did let people hand over their smartphones in exchange for Nokia 3310s, so that they were reachable if necessary.

### **What are your plans for the future?**

We are hard at work now to realise our ultimate goal, that permanent place of ours: Paradise. We hope to find a place for it as soon as possible, so that we really can make the concept permanent. A place where people can come to unwind for a bit. To leave civilisation behind and enjoy the little things in life. We have big ambitions. Ultimately, I want to try and make the world a slightly better place through my entrepreneurship, and do things that are important. For example, Paradise is not just about escaping burnout, depression, chronic stress and the rat race: it is also about protecting nature for generations to come.



---

The use of Extremis furniture took the experience to a much higher level: the combination with nature was a revelation.

---

[Back to  
index](#)



**Our**

TOOLS

**treasured**

FOR

**collections**

TOGETHERNESS

Back to  
index





[Back to index](#)



# G a r g a n t u a

*Quality family time*

Gargantua is a picnic table that the whole family can enjoy, thanks to its adjustable benches. A robust, practical and attractive table that helps us fully appreciate the precious time we spend outdoors.



# About 1994

*The birth of Gargantua,  
the very first Extremis table*



In the early 1990s, the design market was not yet ready for outdoor furniture. Outdoors was a separate category. In most gardens, ornate teak or white plastic chairs prevailed. When Dirk Wynants approached design stores, they showed little enthusiasm for something that was not for the interior. In garden centres, he was even less welcome. These places found design 'far too modern'. The lack of appreciation for well-designed outdoor furniture was a challenge, but this turned out to be an opportunity. Extremis was able to play a pioneering role. Within a few years, we managed to establish our name as an international trendsetter.



The relative simplicity and economy of Gargantua's design are a direct result of technical, physical and budget limitations that Dirk Wynants had to consider while starting up his business in 1994. He could only afford to have one model, one colour, one type and one size. It is said that scarcity leads to creativity, and the most difficult circumstances to the best solutions. In the case of Gargantua, this is undoubtedly true.







extremis

The designer focused wholly on multifunctionality and flexibility. The concept has been considered from every possible perspective. For outdoor furniture, the choice of material is clearly not based on aesthetic considerations alone. Even more the materials used in Gargantua are also geared to a whole range of rational aspects of use, comfort, maintenance, economy and durability. For example, the central piece of the round table consists of a square sheet of perforated stainless steel. This allows for drainage and for dirt to be rinsed away. The underlying idea here is to avoid an intensive clean-up if the sun suddenly emerges and draws us outside. Large pieces of wood have been used for the table's edges. Here, touch plays an important role. Wood is warmer to the touch than metal and is therefore a more agreeable material for those areas with which your body comes into contact.

Much thought was also given to the value of the materials. To minimise waste, the dimensions of the table adhered to standard board sizes. In production, surplus wood was also limited by using small pieces of wood for the benches. The legs and base are made of galvanised steel. Sturdiness and durability have priority over aesthetics. Another practical, economical and environmentally-friendly feature of the Gargantua table is that it is easy to dismantle and transport in a limited volume. This would prove to be a consistent feature of the whole Extremis collection.



- Position 1: adults, young adolescents
- Position 2: children
- Position 3: small children
- Position 4: enlarged tabletop to fit more people with (wheel)chairs



Simply unhook the bench and place it at your desired height.





---

According to an American study, parents and children currently only spend an average of 15 minutes together per day. To improve the quality of this time, Dirk Wynants wanted to create a table where children could comfortably sit at the same height as the adults to enable better communication.

---

[Back to index](#)





←  
The restored warehouse or 'Comptoir Sucrier' by Verdickt & Verdickt architects has a lovely shared garden

↑  
Tailor-made Gargantua with office extension at the CCV offices

Back to  
index





Pop-up art gallery 'Distance'  
at Skyline Communications in  
cooperation with Casteelken.



Stewardesses gathering around Gargantua  
tables that were installed 20 years ago at  
Schiphol International Airport.



A beach patio at the DNA coffee bar  
in Shanghai.



Gargantua with a view in  
the French Alps.









The Interlace apartment building complex in Singapore, designed by OMA and Ole Scheeren, was named 'World Building of the Year' in 2015 - probably because its shared spaces were equipped with Gargantua tables (kidding).

Back to  
index

Extremis



Know more about  
Gargantua



In the city centre of Kortrijk, the cosy summer bar Jardin Bohémien is a real hidden treasure. It's an urban space with lounge music and refreshing cocktails.

Back to  
index





Back to  
index



Extramis

# Inumbra

*Shade, wind resistance  
& pure aesthetics*

Whether you're looking for shelter from rain or sun, together is much more fun. Both versions let you shelter under a solid mechanism with no technical parts in plain view, adding greatly to the cosiness and time you enjoy together.



Collections



© designed by Dirk Wynants

# Reinventing the parasol

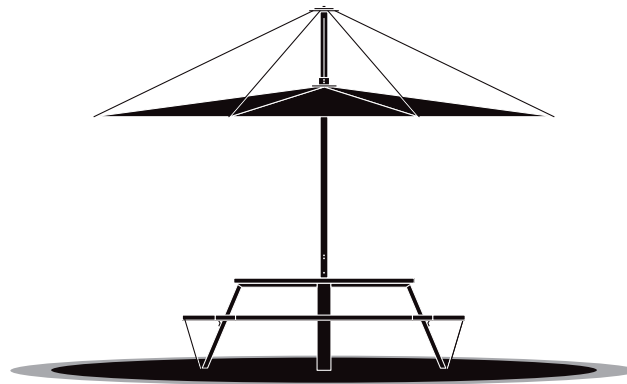

The construction principle of the Inumbr(in)a allows for 17% more shade compared to the classic parasol mechanism.

Why is the most visible part of the classic sunshade, the underside, also the ugliest part? If you sit beneath it, you see a jumble of slats, ribs or ropes above your head. Moreover, traditional umbrellas break very easily. At the slightest gust of wind, they fall over or are blown away. We did not need to think long about our aims for Inumbra. We wanted a parasol that was aesthetically pleasing and much stronger.





With Inumbra, all the technical parts that open and close the screen are above the UV-resistant fabric. Moreover, the flat design of the canopy catches less wind than typical convex shapes. In a wind test, it has resisted wind speeds up to Beaufort force 8.

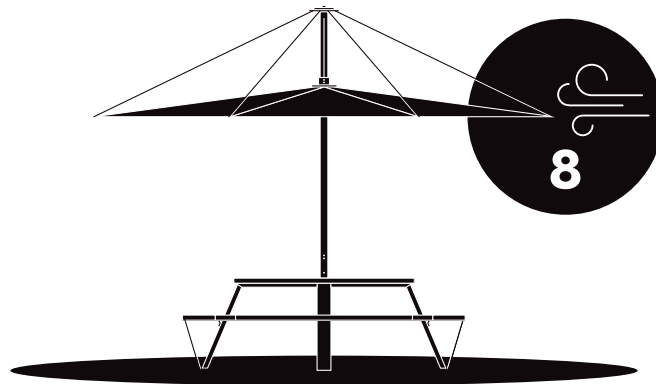

Inumbra resists wind speeds of up to  
Beaufort force 8.

---

Ninety percent of all umbrellas  
produced are still based on the  
opening principle of the traditional  
Chinese parasol. The Inumbra starts  
from a whole new system.

---

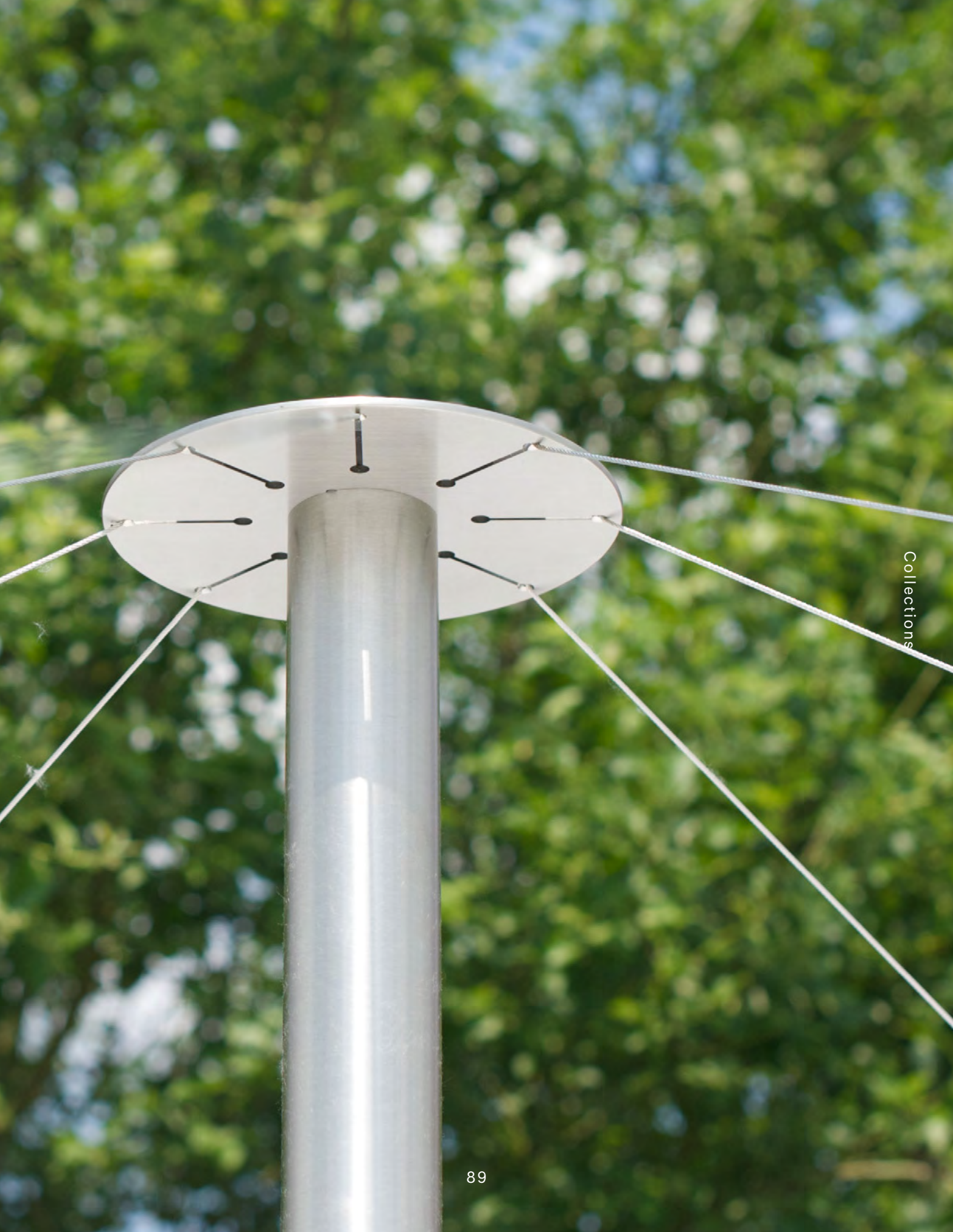



## Inumbra



Inumbra parasol opens and closes by means of a separate handle and an ultra-durable mechanism inside the tube. The cables and the fabric are tensioned by lowering the parasol's fabric, providing more shade because the surface is larger yet closer to the table.

# Inumbrina



Inumbrina is a lighter version of Inumbra and the difference between these two parasols lies in how they are opened. Inumbrina opens by an ingenious pulley and rope system that's simple to use and even faster!



Collections



←  
White Inumbra, ø 400 cm,  
in combination with Gargantua.



←  
Taupe Inumbra, ø 350 cm,  
in combination with Pantagruel picnic.



←  
Black Inumbrina, ø 250 cm,  
in combination with Abachus.



←  
White Inumbrina, ø 320 cm,  
in combination with Anker.



←  
White Inumbrina, ø 380 cm,  
in combination with Pantagruel picnic.



Terraces Comptoir Vénitien by Terrasse et Dépendances  
([www.terrasse-dependances.com](http://www.terrasse-dependances.com)) in Rennes, France.





Shade - brought to you by Inumbra - at a hotel deck with a stunning view in Mallorca.



Interior designer Malika Vanoverbeke created the perfect lunch spot in her garden with a combination of Gargantua and Inumbra.



The wilderness of The Pop-up Hotel in Oostkamp, Belgium.



Back to  
index

Extremis



Know more about  
Inumbr(in)a



Terrace of the University Hospital St. Pölten in Austria with a mix of Inumbra and Inumbrina.

Back to  
index





### Brand photography

Notice anything unique? Gargantua, Inumbra and Pantagruel campaign pictures feature our models in the same configuration, with Brussels waffles, smoothies and Belgian fries. You can even see the kids growing up!

Back to  
index





# Pantagrueel

*A graceful evolution*

The impact of our ideas does ripple outwards and sparks our own creativity in building on previous ideas. In this way, the Pantagrueel gracefully evolved from the Gargantua. It was a logical evolution to which we added refined elements and a handy Lazy Susan.



Collections



© designed by Dirk Wynants



Pantagruel picnic with a set of optional backrests. In the centre you can find an HPL Lazy Susan to easily pass things around.



↑  
Pantagruel picnic with Inumbrina parasol, which offers a lot of shade, thanks to the unique opening mechanism.

Back to  
index



Did you know that Lazy Susan is  
synonym for 'rotating tray' in English?

Extremis



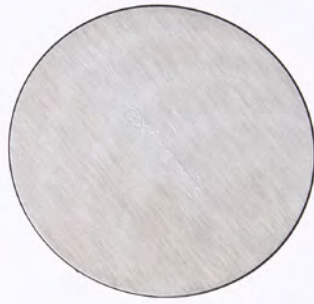

# Lazy Susan

"Somebody pass the butter, please!"



Back to  
index

Extremis



Verdigris powder-coated  
Pantagruel picnic.



Papyrus white powder-coated  
Pantagruel picnic.



→  
Pantagruel picnic, galvanised steel version.



→  
Pantagruel picnic, black powder-coated, with white cushions.



↑  
Pantagruel table.



↑  
Pantagruel high table.

Back to  
index





This galvanised Pantagruel table found its home in a hilly region of Flanders, Heuvelland.





Breakfast served by Lazy Susan, apple juice served by grandma.



Holiday home 'Blauwpoort' has a seminar room in an old barn.







Let's have a pancake party! Should I put white sugar, brown sugar or maple syrup on top? Just give Lazy Susan a gentle shove and pick whatever you like.







The winter garden of the UZ Leuven Hospital, furnished by Feel at Home, features white Hopper and Pantagruel picnic tables - always a nice combo.

Back to  
index

Extremis



Know more about  
Pantagruel



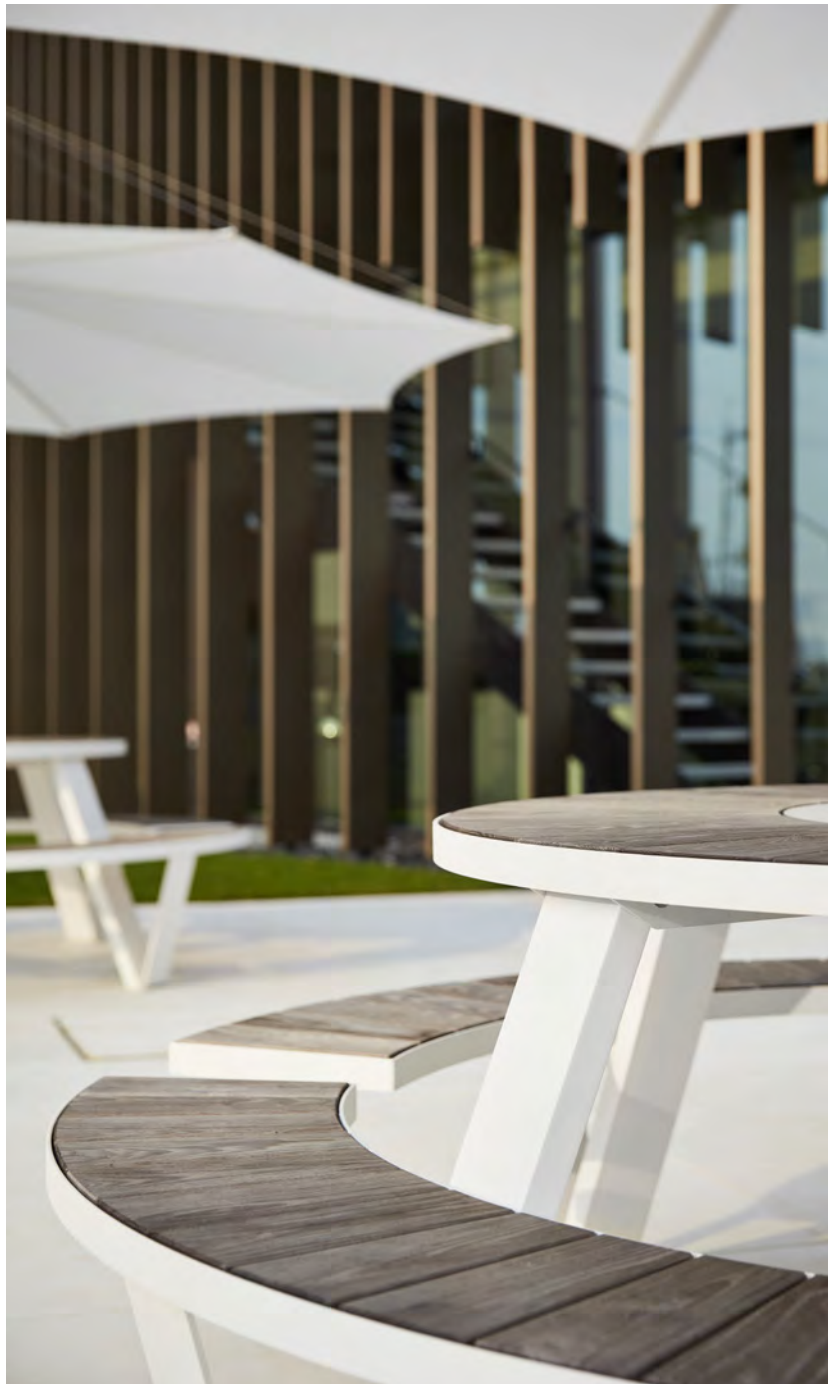

### **Break-out with Pantagrue! & Inumbra**

Building constructor Alheembouw built a headquarters that symbolises their open corporate culture. Together with B2Ai architects, they developed a transparent, state-of-the-art building with lots of glass, concrete and aluminium. Since they wanted furniture that reflects the human-centered architecture of the building, Alheembouw chose Pantagrue! tables, where employees can meet up or have lunch.

Back to  
index





Back to  
index



# Abachus

*Easy leaning, easy talking*

We love cocktail tables. We love the way they encourage casual conversation and allow people to get together for a quick (or extended) chat with a drink. The Abachus intensifies and prolongs every conversation because it has six arms to lean on when standing.



© designed by Dirk Wynants



Arm or side leaning against the tabletop, back or bottom resting against the bars. The most robust cocktail table available for permanent outdoor use.



A perfect match with Inumbrina.

# Supporting people



THE  
I-am-here-to-look-at-people  
LEAN



THE  
I-am-here-to-be-looked-at  
LEAN



THE  
my-friends-are-late-again  
LEAN



THE  
Instagram-selfies-are-hard  
LEAN



THE  
would-you-buy-me-a-drink?  
LEAN



THE  
that-last-one-was-a-bad-idea  
LEAN



THE  
no-time-to-party  
LEAN



THE  
mime-player  
LEAN



THE  
look-how-bendy-I-am  
LEAN

## Saving the leaning people

Look around you at a party or reception and you will very often see guests searching for something to lean against. If you combine an ordinary cocktail table and this desire for support, you end up with the blueprint for Abachus: a high-top table with a real bonus. Six arms to be precise, against which you can lean comfortably. No more awkward leaning positions with this ideal tool for enjoying a get-together with relatives, friends, or acquaintances and drinking in honour of Bacchus.





Back to  
index

Aula is a renowned butcher's shop in the heart of Ghent, which has been refurbished by De Direktewoning. We love their vision of combining authenticity and craft with innovation and creativity. Their patio is the perfect place to grab lunch.

Extremis



↑  
Dranouter festival serving our 'Saison Tremist'.



↑  
Duvel Delta at the Gentse Feesten  
annual festival.

Know more about  
Abachus



The Abachus tables on the balcony of Crosswater's new HQ in Dartford allow the staff to take a breath of fresh air and soak up some sun.

Back to  
index





Back to  
index



# Anker

*Anchored down  
for six*

Anker, the compact 6-seater picnic encourages one-on-one conversations, but its appearance invites people to come on board.



Collections



© designed by Dirk Wynants

Back to  
index

Extremis







In combination with our Inumbrina parasol, it's an awesome eye-catching set up! Get creative with the different colours of wood and steel for a custom combination that suits your way of life.

Back to  
index

Extremis



Anker, white powder-coated with iroko hardwood.



→  
Anker, galvanised version with  
earth centerplate and iroko  
hardwood.



→  
Anker, earth powder-coated with  
hellwood.



→  
Anker, black powder-coated with  
hellwood.





## **Bodo**

A French bistro with a Scandinavian look. It's the neighbour of the famous 'Gravensteen' in Ghent, a medieval fortress with an almost intact defence system. A special backdrop for their excellent dishes, such as rilette or bouillabaise.

# The miraculous space efficiency of hexagons

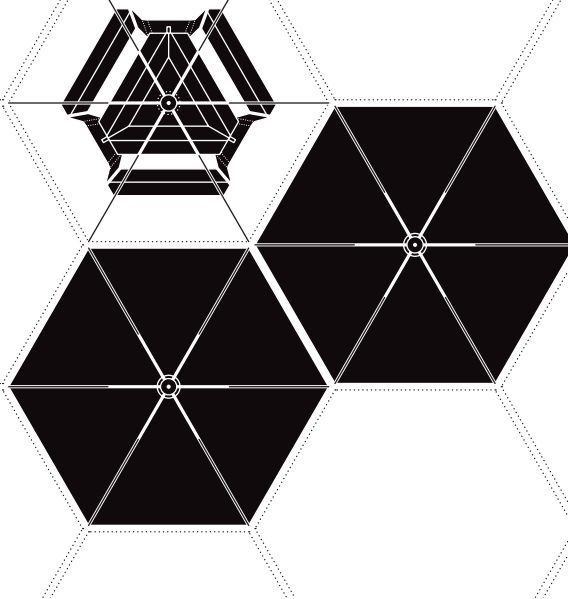

The geometric rules behind insect eyes, honeycombs, Anker tables and Inumbrina parasols are easily explained. Like squares and equilateral triangles, regular hexagons fit together without any gaps to make efficient use of space. For projects on large terraces, the Anker tables can be lined up in a hexagonal grid system to fill the area with a minimum amount of wasted volume, but enough room to easily move around. To keep the sun out and create a cosy ambiance, our hexagonal Inumbrina shades can be installed to construct a closed canopy roof above the Ankers.



Back to  
index







Savouring a delicious breakfast with the family in the woods of The Pop-up Hotel.

Back to  
index

Extremis



The garden of Mr Ito's house in Nagano (Japan) is the ideal setting for afternoon tea.

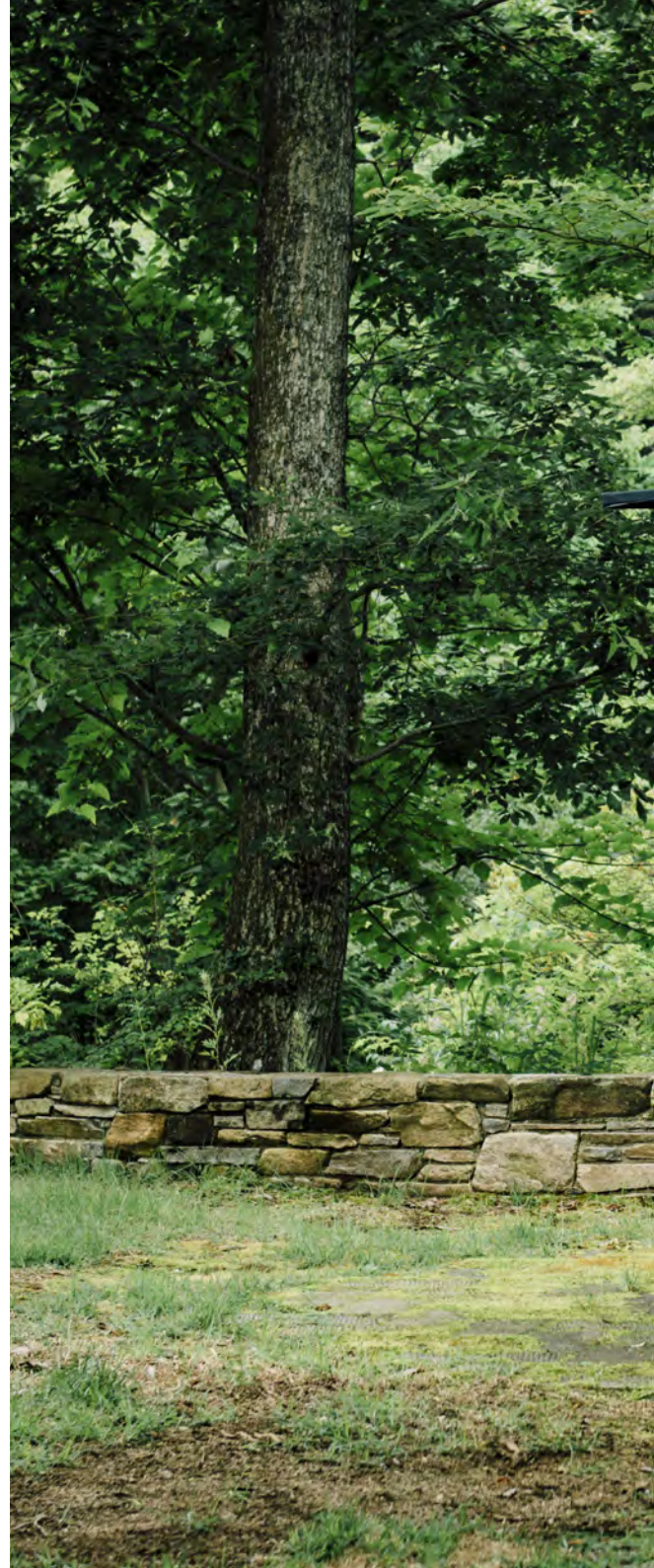



[Back to index](#)

Extremis



[Know more about Anker](#)



Bierkasteel - literally, Beer Castle - is not just a brewery, it also hosts a visitor centre, a brasserie, a conference and event venue, and it has its own shop. Our dealer Rechts van de Kerk made these Anker tables the centre of their courtyard.

Back to  
ex





Back to  
index





# Extempore

*Architecture  
with every functionality*

Extempore is an extensive and modular outdoor furniture range that has been proven timeless thanks to its pure architectural beauty and everlasting materials. For over 20 years, it has been offering solutions for day-to-day needs such as sitting, dining, lying, relaxing, reading, etc. This design classic furnishes rooftops and terraces in New York, Sydney and Tokyo.





Extempore extra high table with extra high benches.



Minimal transport volume and easy to store during winter. Wooden slats offer more comfort and dry faster after rain.

Back to  
index



# Ultimate production efficiency

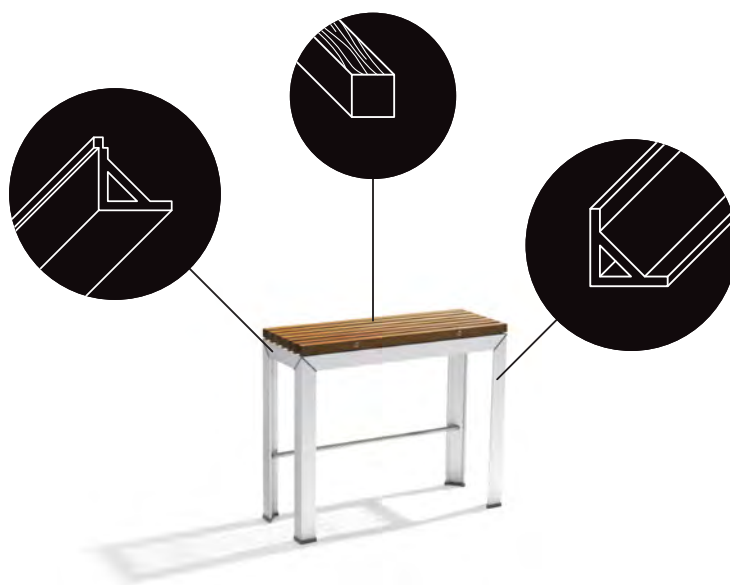

The Extempore range keeps wasted material to a minimum, as each wooden or aluminium element can be used on any product within the range.

[Back to  
index](#)





The ten-storey therapy tower (architects Gonalo Byrne & WIT) on the Pellenberg campus of the UZ Leuven hospital is an innovative rehabilitation centre with a large gym on the top floor. The Extempore benches offer patients and their families a spot to repose and enjoy the breathtaking view.

Back to  
index



Extremis

Sunny day in a private city garden  
with pool.









The perfect evening: a get-together with friends on a rooftop terrace, perfect weather, tasty food, great vibes. Noho, Manhattan, New York.



Back to  
index

Extremis



Know more about  
Extempore



Extempore with a view of the Sydney Opera House.

Back to  
index





Back to  
index



EXTREMES



# Romeo & Juliet

*Green love*

Romeo & Juliet adds some green to our urban living areas, which are often concrete jungles, in order to create a more breathable environment. Except for the bench that keeps equal distance between the trees, this design is ever-evolving, as the trees define the design.



Collections

Winner urban furniture contest,  
city of Kortrijk, 2004

© designed by Koen Baeyens, Stijn Goethals & Basile Graux

---

Bench and planter in  
one. Offers passers-by a  
comfortable place to sit and  
relax. Equal spacing between  
the trees when lined up.

---





This Finnish insurance company installed multiple Romeo & Juliets in front of their office building to cheer up the rooftop terrace.

[Back to index](#)





Chefs for Charity event at castle 'the Lovie'.



Sunlit terrace of a private residence.

Know more about  
Romeo & Juliet

Back to  
index





Back to  
index



extremis



# Hopper

*From hops  
to Hopper*

At a lively beer festival, elegance is almost certainly not the main concern, but this hasn't stopped us from trying to improve access to the classic picnic table. We managed to incorporate more space at the sides to join the party - no more embarrassment about climbing over tablemates to find a place to sit.



Collections



© designed by Dirk Wynants

# Observing and improving

*What inspired the  
Hopper?*



For large parties, we noticed that a round table creates more distance. As several tables are needed, company is split up into a series of islands. In this case, long picnic tables provide a more satisfactory solution. They can be endlessly extended by sliding them together. Beer festivals or other large-scale popular festivals are occasions when a large number of people sit together at long tables to eat, drink and be merry. This is where the typical awkward climbing over benches tends to happen. Living in a beer-loving country,

and more specifically a hops farming region, this was a perfect opportunity to dive into this matter, have a closer look at the problem and try to think of solutions... the day after the party.

The result was Hopper, a tool for togetherness that gathers hops pickers after the work has been done, the centre of celebration. Four pass-through zones make it easy to get in and out of Hopper without having to lift your leg over the bench or disturbing your companions, even when tables are placed in a long row. Its slanted legs and tabletop edges are a clear reference to the hops poles that are so characteristic of the Westhoek region. If you turn around, you can use the tabletop as a comfortable backrest.



---

## Hopper picnic

---

Extremis



←  
Hopper picnic with galvanized legs  
and optional backrests.



←  
180 cm Hopper picnic,  
seating four to six people.



←  
240 cm Hopper picnic,  
seating six to eight people.



←  
300 cm Hopper picnic,  
seating eight to ten people.



←  
360 cm Hopper picnic,  
seating ten to twelve people.

Back to  
index

---

## Hopper table

---

Extremis





---

## Hopper combo

---

Extremis



With four Captain's Chair & one bench.





←  
180 cm Hopper combo,  
with two Captain's Chairs.



←  
240 cm Hopper combo,  
with three Captain's Chairs.



←  
300 cm Hopper combo,  
with four Captain's Chairs.



←  
360 cm Hopper combo,  
with five Captain's Chairs.

---

## Hopper bench

---

Extremis



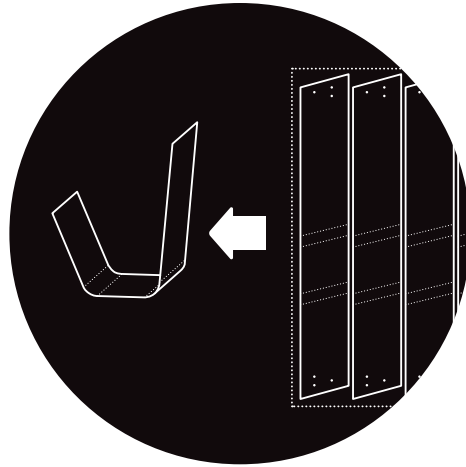

**Eco-design**

Ten Hopper legs are precisely mapped on a standard metal sheet to keep material waste to a minimum.



Hopper bench with a tabletop that also functions as a backrest.

Back to  
index



Extremis

↑  
G-Star Raw® headquarters  
in Düsseldorf, Germany.



↑  
Google premises  
in Zürich, Switzerland.



↑  
Hotel Yotel is a stylish, contemporary hotel in the heart of Midtown West. Did you know it has the largest outdoor hotel terrace in New York City?

Back to  
index

Extremis



The beautiful new Science Campus of the University of Leiden in the Netherlands features multiple Hopper picnic tables on different levels, thanks to Hora Barneveld.





At the RJV offices, Pami workspace designers created an interior that is geared to the new way of working, combined with cosiness and a homey atmosphere.





↑  
Hopper picnic & shades with a view  
of the Burj Khalifa in Dubai.

Back to  
index





The sleek design of the Hopper picnic gives the garden of landscape architect Bart Monbaliu this rural farmhouse a contemporary touch.



→ Hopper combo with Captain's Chairs at Ten Doele in Middelkerke, Belgium.

[Back to index](#)







→  
Hopper picnic and  
shade on the terrace of  
a private residence by  
interior architect Pieter  
Vanrenterghem.

The Hopper picnic blends  
in perfectly at the central  
courtyard of this brutalist  
residence by Clauwers &  
Simon Architects.





[Back to index](#)





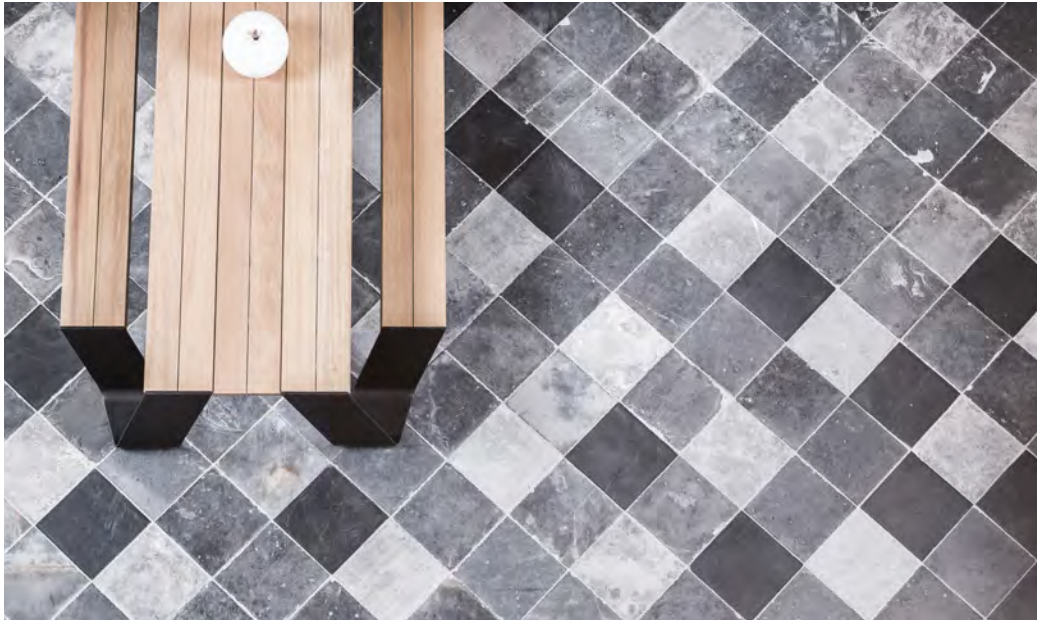

### **'Outdoor space' inside a 16th century chapel**

This 16th-century chapel in the centre of Sint-Truiden was given a new use in 2016 as a work and exhibition space for the architects of Klaarchitectuur. The protected monument underwent a thorough renovation and now combines the old character of the original building with modern additions by architect Gregory Nijs. The four stacked boxes, which serve as an office and conference room, transform the inner space of the chapel into the outdoor space of the office. A staircase complex around the boxes provides an extra experience. The black Hopper picnic, delivered by our dealer Carmetum, fits perfectly with the original natural stone floor, which features a diagonal cross pattern.



Courtyard of the Frankfurt  
International School in Germany.

The rooftop terrace of the Arhus public library in Roeselare offers an amazing view of the city and is an extension of this vibrant meeting place, where research, knowledge, people and ideas come together.





Hopper picnic and Walrus in this private garden,  
designed by Tuinonderneming Monbaliu.



Know more about  
Hopper

Back to  
Index



# Hopper shade

*Clearly inspired  
by hops fields*

Both opened and closed, Hopper shade perfectly follows the lines of the Hopper table. It opens and closes effortlessly, thanks to an internal spring mechanism that does not take up extra space next to the table.





←  
Hopper shade closed.



←  
The cloth can be stretched out  
either to the left or right, or in both  
directions to protect everyone.





Back to  
index



# Saison Tremist

*The togetherness beer*



What do beer and design both have in common? Well, the Extremis Hopper table was inspired by the hops fields enveloping the company premises, for one thing. But that's not all. The typical Extremis design method was applied on the creation of the Tremist beer. It was initially crafted with a view to spoiling company visitors with an exceptionally refreshing, infinitely drinkable (for some of us at least) beer. The result reflects the same (tenacious) character as our other creations, the 6.2° beer boasts an authentic,

high-quality flavour without being too heavy. Due to the highly international nature of Extremis business operations, shelf life was also an extremely important consideration. This is why a hoppy, blonde "Saison" style beer was chosen; reminiscent of the pale ales that farmers traditionally brewed in the winter to provide their seasonal workers with some welcome summer refreshment.



Beer virtuoso Rudi Ghequire translated Dirk Wynants' exacting beer wish list into an exquisite recipe that's perfect when served in the special glass designed by Belgian metalsmith Nedda El-Asmar. The beer is brewed in a truly unique location: the ancient Kazematten Brewery, ensconced within the 17th-century fortifications that encircle the city of Ypres. In recent years, the improved recipe has regularly been imbibed at international trade fairs and events launching the latest Extremis creations. Unable to resist the countless pleas to make our beer available to all any longer, we finally entered into a distribution partnership with the Sint Bernardus brewery, a worldwide exporter of Trappist beers. Thanks to them - and the great taste, of course - the first Tremist-serving bars are popping up in the United States, Japan and Scandinavia, and the beer will be gracing the shelves of Belgian stores, too.



Know more about  
Tremist



In 2010, Extremis delivered its first Hopper shade at a private residence, right next to the church of Poperinge. The night ended with a fun party!



Terrace area of restaurant Va et Vient, where you can enjoy delicious and creative dishes with prominent roles for seasonal products from local producers, sometimes with a foreign twist.

Back to  
index



Shinagawa season terrace in  
Tokyo, Japan.





SHINAGAWA SEASON TERRACE

SHINAGAWA SEASON TERRACE

SHINAGAWA SEASON TERRACE

SHINAGAWA SEASON TERRACE

SHINAGAWA SEASON TERRACE

Back to  
index



Know more about  
Hopper shade



A new oasis of calm in the city centre of Brussels. Cities are increasingly lacking places to escape the fast and impersonal metropolitan pace. Sharing time with friends to eat, talk and gather together are seldom moments of fresh air. Therefore, MINI LIVING created the installation "Breathe": this island uses natural, affordable, easy-to-use materials like a new breed of honeysuckle plant and olivine stones in water and soil to purify the surrounding air. Extremis picnic tables and shades invite passersby to take a seat and enjoy the city.

Back to  
index





[Back to index](#)



# Pontsūn

*An extra-wide table  
with origami-like legs*

This extra wide table was dubbed Pontsūn, Japanese for 'pontoon'. Indoors or outdoors, get together with plenty of friends around this large, elegant table.



Back to  
index



Extremis

↑  
Galvanised steel legs.





↑  
White powder-coated  
legs.



↑  
Black powder-coated  
legs.



↑  
Pontsūn with earth powder-coated  
legs & black Captain's Chairs.



### **The first lunch**

Pontsūn proves to be the perfect table to gather a lot of people around. Our marketing team set up a barbecue for the whole Extremis team in order to enjoy a quick lunch in the sun. The neighbouring castle garden, owned by uncle Henri, hosted this sausage (literally) fest. This is Belgium, as pretty as it gets.





Back to  
index





Interior stylist Malika Vanoverbeke created a welcoming outdoor dining area in her own backyard with the Pontsūn table and Captain's Chairs.

Back to  
index

Extremis





Know more about  
Pontsun

Put your Pontsūn table inside to make your interior an extension of the garden. This large, elegant, wooden table combines perfectly with Extremis' Captain Chairs.

Back to  
index





ext



MAPIVA  
DIREZIONE PER SPINA, SERRAVALLE & PAVANZANO  
DIREZIONE DI MONTE, MONTOROTONDO & MONTICCHIO

[Back to index](#)



# Marina

*Let's talk*

A table can never be too long if it encourages more people to interact with each other. That's something we take very literally at Extremis. The Marina is designed for both small groups or infinitely large crowds. Want to get to know your neighbours? Marina encourages you to talk to each other.



Collections



© designed by Metrica

---

Standard available up  
to 12 m in one piece.

---

Extremis





↑  
Marina picnic comes in two widths and  
20 different lengths.



Marina combo, chairs for daily use, benches when you're having friends over. Superstrong fibreglass profiles - no frame at all.



Marina table, with matching Captain's Chairs, comes in two widths and 15 different lengths.

---

Marina comes in endless  
variations. Check out  
[www.extremis.com](http://www.extremis.com) for all  
lengths and possibilities.

---





→  
Marina bistro.



↓  
Marina double desk, two  
tabletops, one set of legs.

↑  
Marina high table.



[Back to index](#)



# A world record?



In the run-up to the Interieur 2012 Biennale in Kortrijk, Extremis produced the biggest 'tool for togetherness' in its 24 years of existence: a thirty-meter table with more than a hundred seats! But how do you transport a table that size from the supplier in Oudenaarde to the exhibition halls in Kortrijk? Extremis strives for sustainability in the design, production and distribution process of new products. Transport is a key point. The 30-metre Marina table was produced by a pultrusion company located next to the Schelde river and it was brought to Kortrijk by ship, the ideal transportation method!

In the meantime, many of these long Marina tables help people get to know each other in the cantinas of companies like Creax, Nike, Porsche, CCV or hotel terraces like that of Citizen M in Paris.

**Watch the video: [www.extremis.com/longestmarina](http://www.extremis.com/longestmarina)**

Back to  
index

---

Long tables encourage  
meeting new people.

---

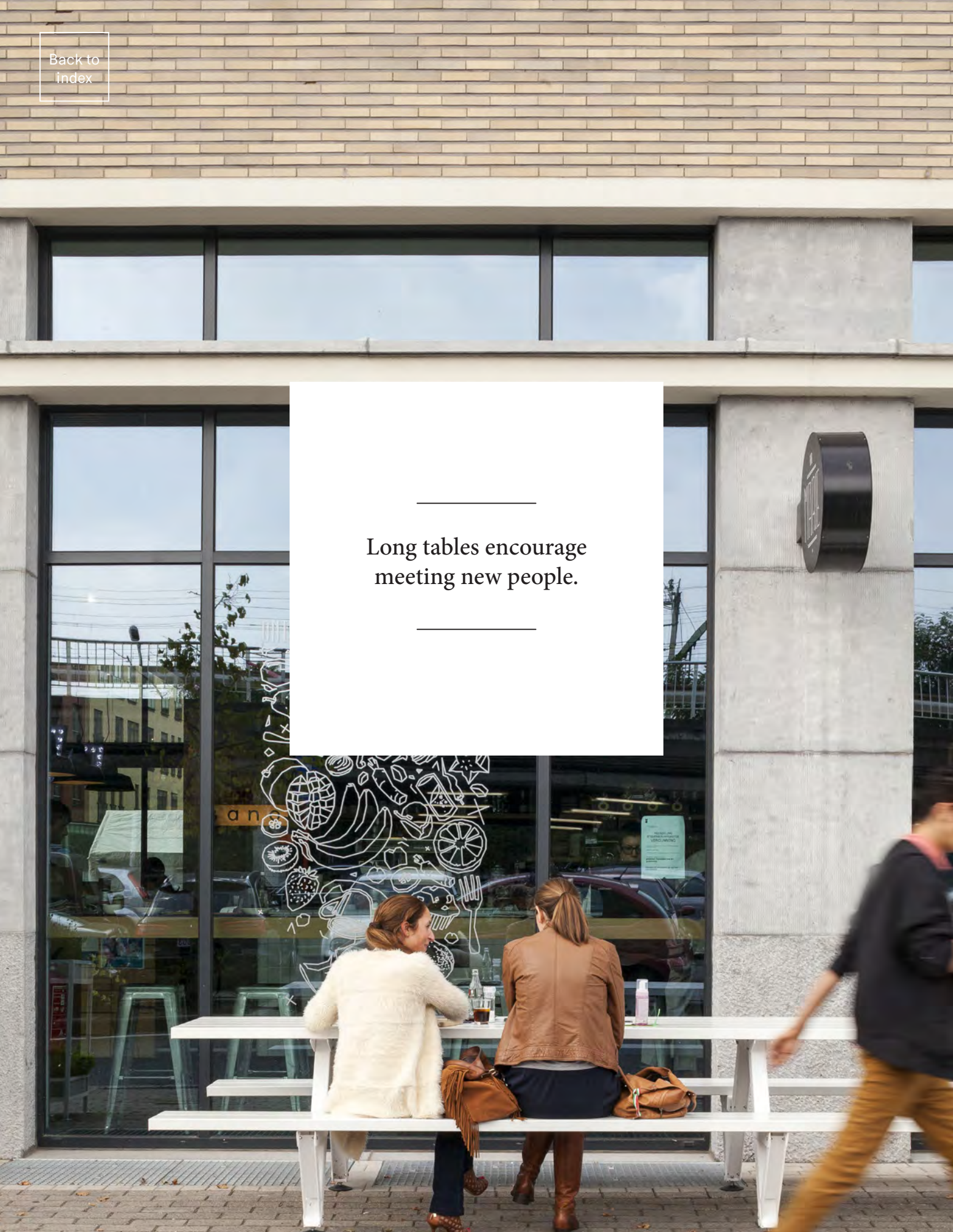



Bar Marie in Mechelen was designed by Creneau International.



MHP - a Porsche company. The purpose of Porsche's Digital Lab in Berlin is to identify and test innovative information technology solutions. The long Marina picnic tables stimulate collaboration and creativity.



↑

Connecterra is the main gateway to the National Park Hoge Kempen. The location was actively used for coal mining until its closure in 1987. Nowadays, you can enjoy a surprising change of the landscape with spectacular panoramic views.



↑

Peter Jannes from Ontwerpatelier is the architect of this private home, where the Marina combo is the centrepiece of the terrace. The Captain's Chairs are for daily use, while the benches are used when friends come over.

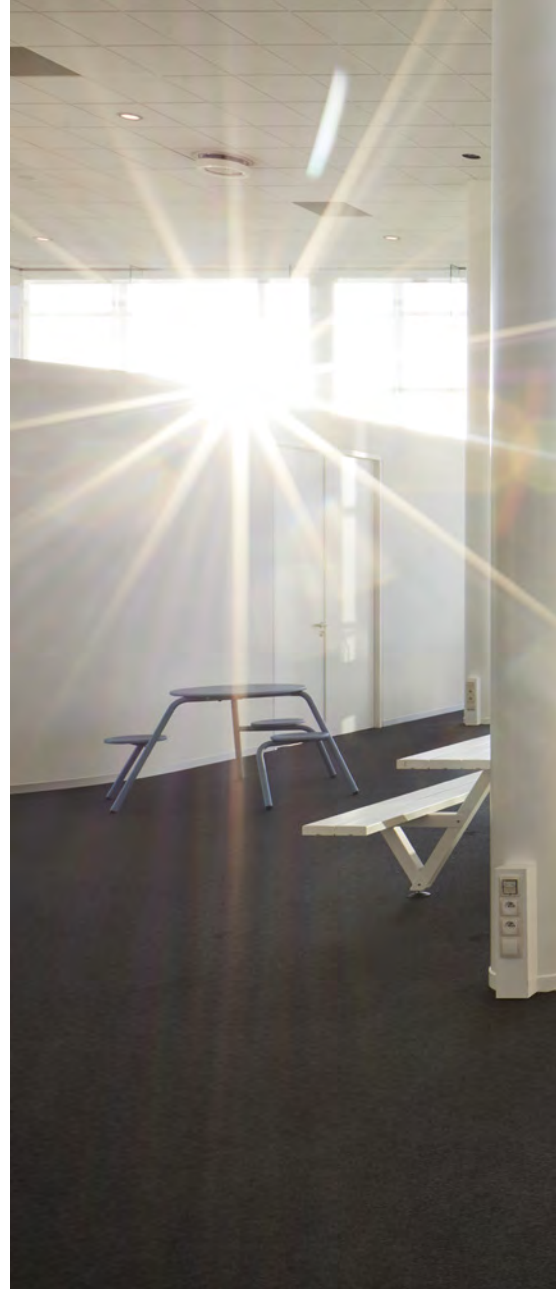





CCV is an expert in electronic payments, and they are convinced that having lunch with colleagues at long Marina tables is the best way to recharge their batteries for another busy afternoon.

[Back to index](#)





←  
Workshop of Wonders designed the Eat & Meet area for Nike's European Headquarters in Hilversum. To capture the Nike DNA in this hotspot for formal and informal meetings, they chose Marina picnic tables.

↑  
At the citizenM hotel in Paris, La Défense, floor-to-ceiling windows lead out onto the large sun deck, where guests can enjoy a drink at the Marina table or Pantagruel picnic with a view of the impressive Grande Arche.

---

In the end, the table found  
a home in Ypres, where it  
also serves as a visual border  
between the home and the  
horse paddock.

---







The Omniplan architects worked closely with the Billingsley Company to develop the offices of Cypress Water in Dallas, Texas. The Marina combo helped create a true sense of place, supported by a diversity of uses.



The interior architects of BroekBakema and Aarts & Co designed the offices of Trinseo to have a homey atmosphere with lots of plants and attention to detail.



Bert & Lies had the cosiest garden party at their home, with a very loooong Marina combo table, Captain's Chairs and Icecubes.





The Marina combo looks stunning on the terrace of holiday home Acotée d'O, which was designed by Pieter Vanrenterghem's Interior Architecture Studio.

Know more about  
Marina

Back to  
index





[Back to index](#)



# Captain's chair

*The most comfortable of them all,  
Burgundian-sized*

This looks like a normal shell chair that lacks innovation and added value, right? Wrong! As soon as you get comfortable in the Captain's chair, you'll notice that it's different. Its wide shell offers the ultimate in seating pleasure, even for large or tall people.



# For all seasons

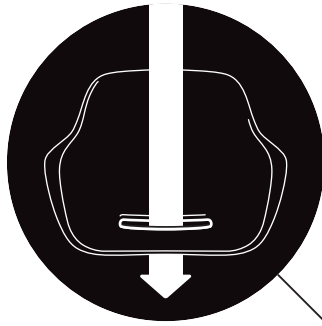

**100% Fast drain**  
Keeps the seat dry  
and clean



**Cushion  
positioner hole**



As you can see, a storage net under the seat stores your bathing towel in summer and your ski goggles and gloves in winter. But there's more than meets the eye. The combination of seat inclination, the composition of the shell material and the water drainage hole ensures that your seat stays clean longer, even when it stays outside all year long. The specific design of the cushion seamlessly follows the curves of the shell, making sure it doesn't blow away.

ERGUNOTTI

100% FAST DRAIN

=

DRY + CLEAN



HANDLE

VENTILATION



ERGUNDIAN  
SIZE



ARM REST

# For all sizes and ages



The Captain's chair was designed by Metrica (Bruno Fattorini and Robin Rizzini) at the same time as the Marina range. Their aim was to create an extremely comfortable chair for people of all ages and statures and to partially replace the more youthful seating benches around the Marina combi. The final result is a shell-shaped chair that draws inspiration from yacht helm chairs and offers unrivalled seating comfort. The super-ergonomic chair can even be upgraded with a loose seating cushion or a completely upholstered seat.









↑  
Storage net optional with Captain's rolling chair and paw chair.

---

Captain's chair comes  
in various options for  
the bottom frame.

---



Back to  
index





Blauwpoort is the beautiful luxury lodge of stylist Nathalie Lermytte in Westouter, Belgium. She welcomes her guests to its three buildings, which all breathe comfort, design and creativity.

→  
The black Captain Woody's chairs look gorgeous in the stylized living room of Blauwpoort.

Back to  
index







The best conference room chairs feel as good as they look. Captain's Rolling Chairs with upholstery at the Belgian CCV HQ aren't just comfortable, but also durable.





[Back to index](#)



→

The Chefs for Charity created high-top seating with Marina high table and Captain's high sliding chairs.



Collections

←

Spa and hotel Wu Wei has a cosy patio with Marina bistro tables and Captain Woody's chairs.

Back to  
index

Extremis



Know more about  
Captain's chairs



With a surface area of 66,500 m<sup>2</sup>, the Herman Teirlinck building by Neutelings Riedijk on the Tour & Taxis site in Brussels is the largest passive building in Belgium. The Captain's chairs in one of the winter gardens can be used for meetings or lunch.

Back to  
index





[Back to index](#)





# Sticks

*Playing with space*

A space divider and the perfect way to create privacy wherever needed, inside or outside. Sticks optically divide your office or terrace without causing it to lose its feeling of spaciousness.

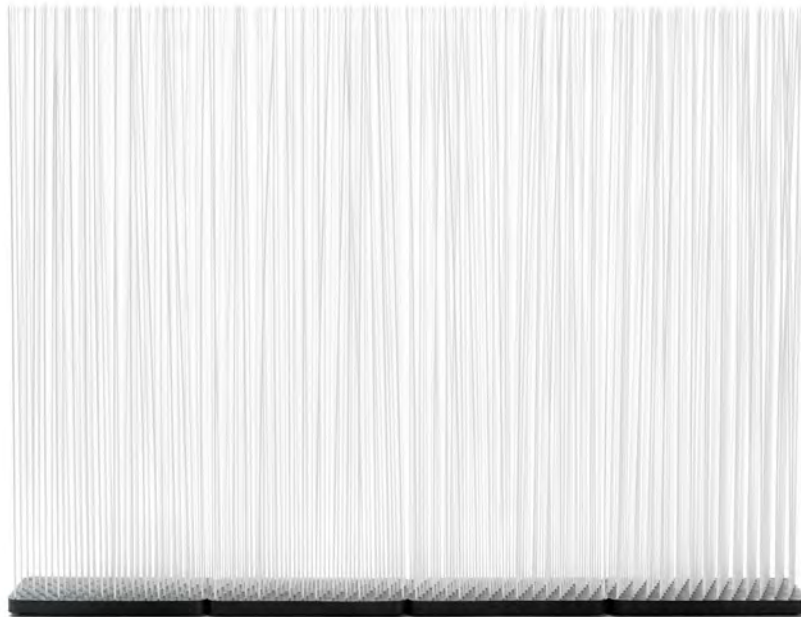

Collections

© designed by Hsu-Li Teo & Stefan Kaiser

# Modular by nature



Sticks is probably the simplest design ever with the potential to become an iconic design piece. It is loved by corporations, the retail market and the hospitality market. It always comes in handy in your home, too: it's like having plants that don't need watering. Your imagination is the limit to its use. The curved Sticks bases combine perfectly with rectangular bases and let you create all kinds of patterns, from straight lines, angles and wavy lines to semicircles or even complete circles. The design of Sticks ended the search for a multi-use screen with both indoor and outdoor applications, as it is not blown over by the wind.







↑  
Curved bases in two  
different versions to make  
a circle of 2 or 4 metres  
in diameter.

[Back to index](#)





Illuminated sticks at a private residence in Kuwait, designed by architect Bab Nimnim.





Sticks in our headquarters.





Collections



→  
The sticks at the  
Mandarin Oriental Hotel  
in Miami create a cosy  
atmosphere.





Pami designed the new Melexis offices as a very open workplace. The sticks create privacy without losing the sense of freedom.



The Showfloor is a new trend in the real estate world. It is the ultimate way to show all the possibilities of office space to future tenants and buyers. Buro Project used our Sticks to work a full showfloor in the Covent Garden building, a business center in Brussels.



The Sticks already create a play of light and shadows by themselves. However, you can get truly astonishing light effects if you opt for bases with integrated LED lighting. It gives this swimming pool an extra dimension at night.

Know more about  
Sticks

Back to  
index





[Back to index](#)





# Picnik

*Art for two  
forever*

A table seating combination specially created for couples, today's most common family unit. The iconic design has been shaped by solely practical design solutions: the curved surfaces result in quick water evacuation, improved seating comfort and incredible strength, while the whole piece is still stackable for transport.



Collections



I.D.



imm  
cologne



© designed by Dirk Wynants & Xavier Lust

[Back to index](#)





Picnik, structured powder-coated in copper brown & black.



Picnik, structured powder-coated in verdigris and cobalt blue.

Back to  
index



# Designing the Picnik

*A desire for great simplicity*



Every aspect of Picnik's shape is based on a functional need. One flat aluminium sheet is transformed into a picnic table, thanks to a number of strategic incisions and folds. The rounded surfaces are necessary to increase its strength; the sloping feet are necessary to enable the tables to be stacked. But how did the design come into being?

Things that look simple are often the most difficult to design. Dirk Wynants does not feel that sketches are needed for an idea mature to an advanced stage. In his opinion, spatial thinking always offers greater freedom than pen and paper. It's easy to illustrate the Picnik idea using a simple sheet of paper by cutting and folding the paper to create a tabletop with benches attached. The idea was to develop this at full scale from a single standard sheet of aluminium.

After much experimentation, it became clear to Dirk Wynants that Picnik could only achieve the necessary structural strength if the material was reshaped or 'rolled'. Coincidentally, the Belgian designer Xavier Lust had just made use of this technique in his iconic 2000 piece 'Le Banc'. Collaboration between the two designers seemed to be the obvious way forward.

---

One flat aluminium sheet is transformed into a picnic table, thanks to a number of strategic incisions and folds.

---



The basic shape is exactly half the size of a standard 3 x 1.5-meter aluminium sheet. Apart from the saw cuts and minimal rounding off, material wastage is nil.

[Back to index](#)

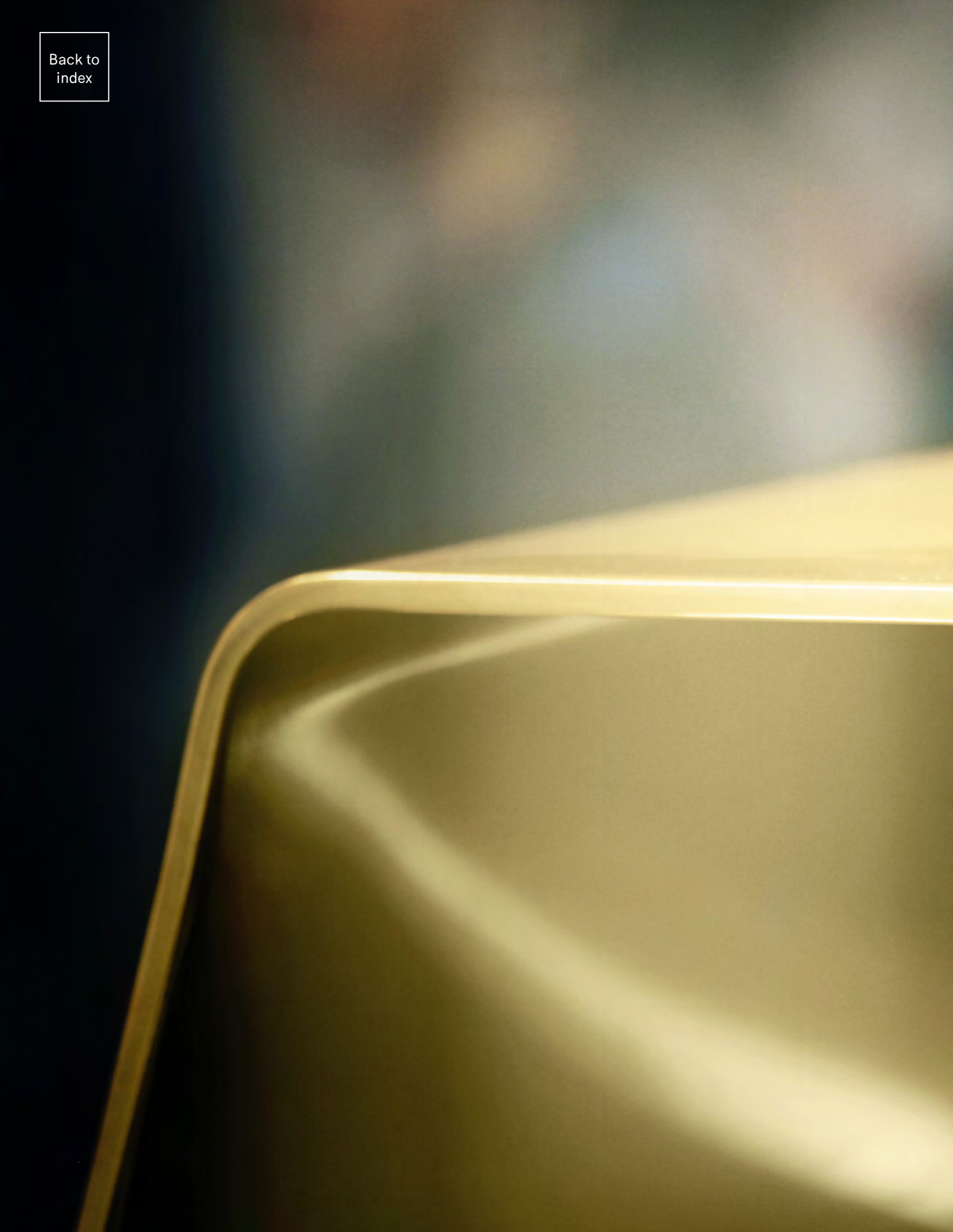





15 years of Picnik, that is cause for a celebration! We added some bling bling by giving the Picnik a brass coating so it could shine bright at Salone del Mobile 2017.



The head office of the Dutch drinking water company PWN was renovated by Kraaijvanger Architects. To emphasize their company colours, they selected blue Picniks at the entrance of the new atrium.



These colourful Picnicks add a playful twist to the architecture and the aesthetics of the Frankfurt International School.

[Back to index](#)





The contrast between the old Lovie castle and the glossy white Picnik is very refreshing.



Pop-up art gallery 'Distance' showcased the work of local artists and Picnik helped spectators share their thoughts.

Know more about  
Picnik

Back to  
index





Back to  
index





# Virus

*Playful  
and cheering*

Oh, city life. Embracing living closely together, intensifying interaction.  
Escape rush hour and invite someone to your Virus table!





## Architectural threesome

---

Extremis



↑  
Papyrus white, verdigris & bottle green  
structured powder-coated.



Virus with optional backrest.





## Playful threesome

---

Extremis



↑  
Beige red, verdigris & cobalt blue  
structured powder-coated.



## Hot threesome

---



Collections

↑  
Black red, copper brown & beige red  
structured powder-coated.

# For any space

---

A playful picnic table  
for 2 / 3 / 4 / 5 people

---

Virus brings life and dynamism to even the most sterile places. The compact design responds to the trend toward smaller living spaces and offers a solution that enables you to use our tools on balconies and in urban gardens. There is a Virus picnic table that is ideal for any kind of gathering. Expect nothing less than togetherness, anywhere!

Extremis



Collections







### **A vegan bakery**

This was the pop-up of Madam Bakster - the guilt-free bakery - in Bruges, Belgium. It goes without saying that the Virus tables are the perfect place to enjoy a healthy snack and juice!





### **University of togetherness**

Our Virus picnic tables are the centre of the University college VIVES in Bruges. The tables in various colours and a mixture of small to medium-sized seating sets encourage the students to connect with each other - the old-fashioned way.



At the Hopmuseum in Poperinge, you can learn all about the history of hops plants and how they make your beer taste so delicious. Afterwards, you can get hold of a bottle of Saison Tremist beer, our Belgian Farmhouse Ale. Cheers!





↑  
Virus was successfully launched  
in Asia during Interior Lifestyle, a  
must-see design event in Japan.





At CCV Belgium, the multi-functional breakout space consists of Virus and Marina tables. The area stimulates interaction & relaxation as a place where co-workers can take a break from their work, but it's also a place to hold quick informal meetings.

[Back to  
index](#)



[Know more about  
Virus](#)



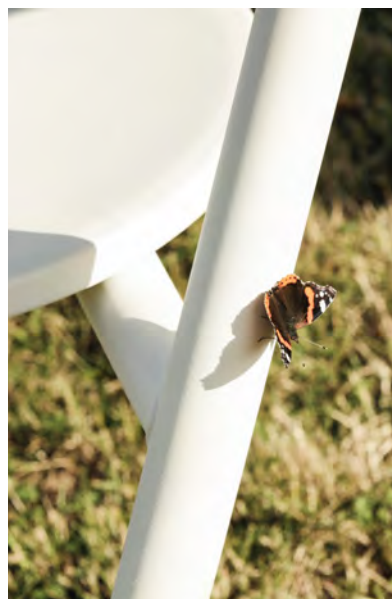

A beautiful summer day, sipping a glass of Ricard in a quiet meadow garden... Listening to the sound of nature... We get sentimental just by looking at these pictures!

Back to  
index





Back to  
index



# Walrus

*A sleek  
weatherproof sofa*

This design combines two different materials in order to fulfil the seemingly irreconcilable requirements of high comfort levels, aesthetics and ultimate weather resistance.



Collections



© designed by Dirk Wynants

# Solving the paradox of the outdoor sofa

At Extremis, we've always considered  
the outdoor sofa a strange paradox.

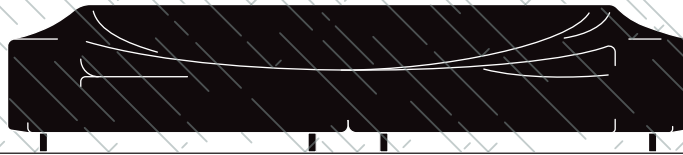

In our rainy part of the world, you often get the impression that people have purchased a protective cover to put in their garden, since this is mainly what you see. So, when we decided to design our own outdoor sofa, we knew it would be one without a protective cover and without the hassle of cushions. We turned the whole idea inside out: the sofa became the protective cover, and we put the cushions safely hidden on the inside of the sofa. In case of bad weather, there's no need for protection. When the sun decides to shine, you have instant dry seating.

Walrus itself is made of weatherproof cover material.

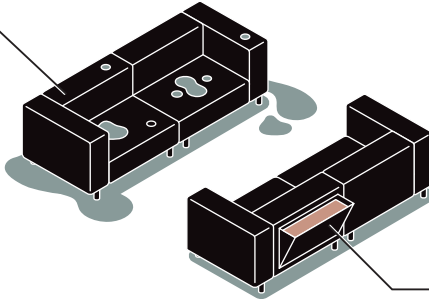

The foldout blanket and comfort cushion are hidden inside.

With Walrus, there's no need for protection in case of bad weather.

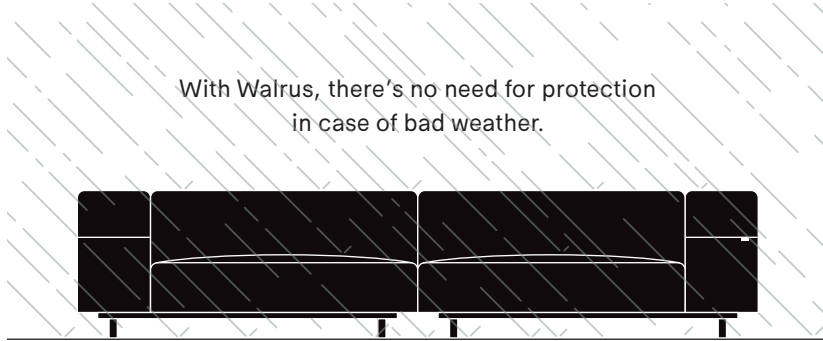

When the sun decides to shine, you have instant dry seating.

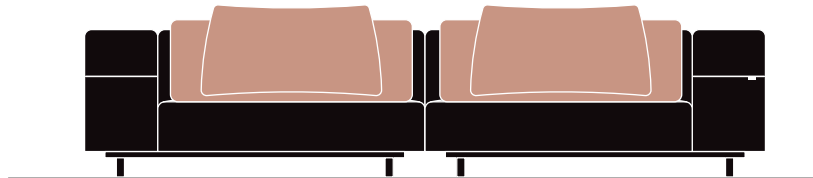

---

It took our colleague Ferre only 7 seconds  
to prepare a Walrus for comfort seating.  
Who will break his world record?

---

Extremis



An ingenious storage pouch in the back  
of the Walrus hides a foldout blanket  
and a back cushion. Open the pouch, unroll  
the blanket, and close the magnets again.





A warm, dry and snuggly place to sit is instantly available whenever the sun comes out. Yes, even in winter!

Back to  
index

## Frosted blue combo

---



## Vintage red combo

---



Back to  
index

## Fresh mint combo

---





↑  
Club chair with mint green blanket, leaf green comfort cushion & white deco cushion

## Modularity

---

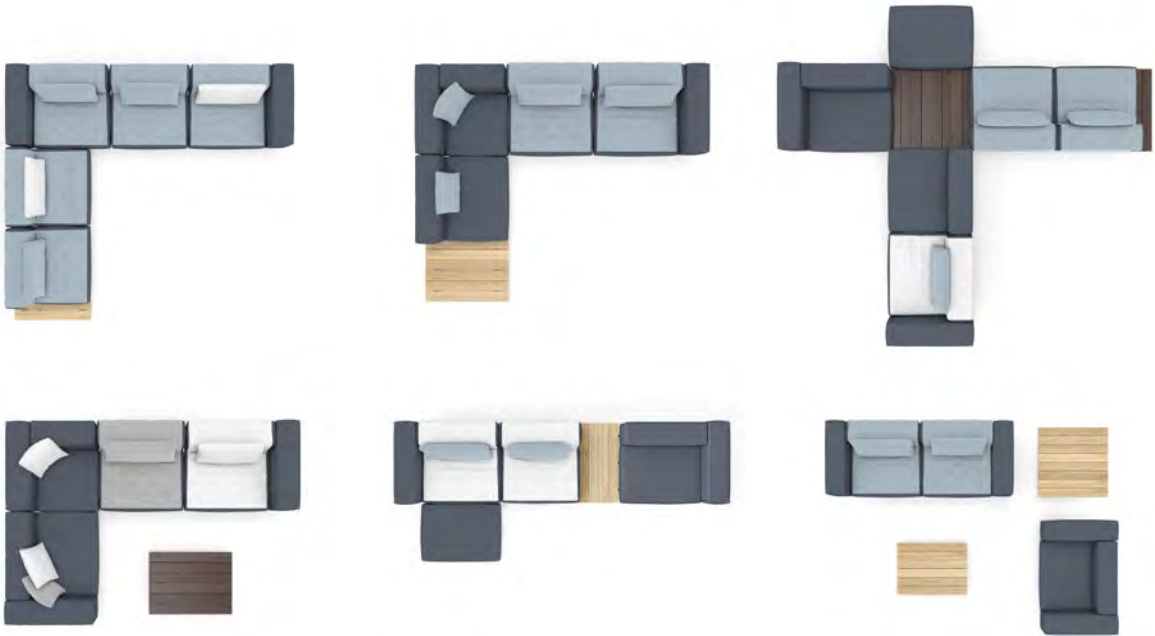



At this spa and hotel, called Wu Wei, Walrus invites a guest to enjoy a glass of champagne, or for some more relaxing in between a massage and a swim.



[Back to index](#)







Need room for your food and drinks or anything else while you are enjoying the Walrus outdoor sofa? The compact coffee table is the perfect fit!

[Back to index](#)

extremis

[Know more about  
Walrus](#)



For each Walrus building block, you can add a blanket and cushion. They aren't only soft and comfortable, they are also water and dirt-repellent and machine washable.

[Back to index](#)





Back to  
index



# K o s m o s

*Talk, eat, siesta*

Convert your Kosmos table-seat combination into a lounge bed by putting the gas spring table at its lowest position and adding a cushion. This ingenious set takes you right through the day - from breakfast to sunbathing - without stuffing your roof terrace full of furniture.



© designed by Dirk Wynants

Back to  
index



→  
Choose between a fixed or  
adjustable table.

Extremis



←  
Perfect for indoors and outdoors.  
Simply push the table down to  
create a daybed.





---

The cushions come in a range of  
colours and materials.

---



Collections

EXTREMES KOSMOS

Back to  
index

Extremis



# A world on its own



The intimacy and versatility of a yacht's cockpit inspired Dirk Wynants in his search to combine all functionalities in one and save space. Kosmos is the compact alternative to a combination of dining table, chairs, lounge chairs, sun protection, dimmable lighting and so on. Let's call it a complete world on its own.

Back to  
index

Extremis





---

Spend an entire day in  
the Kosmos.

---

This designer sofa is a clear reference to the world of sailing ships and yachts. The table/seat combination makes efficient use of the space available by combining different functions, such as a sofa, a dining table, light, a parasol, and a daybed (the adjustable table becomes part of the bed). The Kosmos 8-seater is the Swiss knife of the collection, you do not need any other furniture when you have this designer sofa.



Back to  
index





←  
Kosmos at a rooftop terrace  
in Vienna.

↑  
Meeting space at Kinki  
University, Japan.

Know more about  
Kosmos

[Back to index](#)





# Kosmos parasol

*Opens horizontally like a fan*

Kosmos parasol is an ingenious design that opens horizontally like a fan, offering excellent wind resistance. It hangs low enough to provide plenty of shade, and is perfect for placing next to the Kosmos table and seat combination – or any other furniture.



Extremis



Kosmos parasol opens horizontally. Two hidden magnets keep the parasol open. In very windy weather, the magnets will release their grip and the parasol will close automatically.



Round white Kosmos parasol with optional dimmable LED light.



Square taupe Kosmos parasol with optional dimmable LED light.

# A simple idea, a patented system

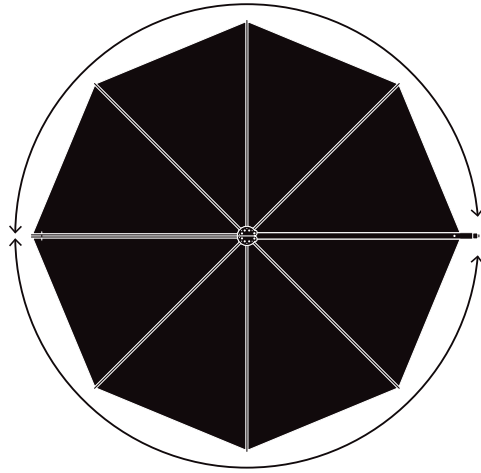

The Kosmos parasol was created separately from the round Kosmos sofa. Designer Dirk Wynants wanted an umbrella that does not stand in the way when it was closed. The Kosmos parasol, inspired by nature! The original innovation is that it simply opens and closes horizontally. Apparently, no one had ever come up with this system, so we patented it. The advantages of the fan system are numerous: the parasol is very easy to open and close, it hangs low enough to provide extra shade and creates an intimate atmosphere. It has a simple, clean look, as there are no visible technical components, and no hole is required in the table. Two hidden magnets keep the parasol open. In very windy weather, the magnets will release their grip, so the fabric loses its tension and the parasol stays put.



Back to  
index



Free-standing square Kosmos parasol  
bringing shade to the bright white Walrus sofa.

Extremis



Kosmos with a view  
at Lake Lucerne in Switzerland.



Know more about  
Kosmos parasol

Back to  
index







Back to  
index



# Sol + Luna

*The sunbed sofa or sofa sunbed*

Sunbathe during the day, lounge with friends by night. Take it easy in our Sol+Luna sunbed, which transforms into a comfortable sofa at sunset. The optional sun shade changes into a full moon every night.



Collections



© designed by Dirk Wynants

Back to  
index

Extremis



# The dilemma: a sofa or a sunbed?



When arranging your outdoor space, Googling 'loungé furniture' leads to either sofa sets or sunbeds. Why do all designs fall into these two categories? Hasn't any customer ever asked why they have to choose between the two?

### **Space is becoming too precious**

Before Sol+Luna, the best solution was to acquire both and lose a big chunk of your terrace. Now, you can make optimal use of your patio! Just imagine: a lazy day in the sun, a siesta or a relaxing break with a book. In the evening, your best friends drop by unexpectedly as the sun is going down. Great company, tapas and a mojito with mint from the garden... a dream weekend. We came up with the ideal 'tool' to make this happen.

---

**Sol+Luna, or sun and moon in Spanish, is a name that reflects the double purpose of this new piece of furniture.**

---

Sol+Luna is a two-in-one piece: furniture that is functional by day and by night. The Extremis single recliner is also a three-seater sofa, and a set of two recliners becomes a suite for six people. Just toss on a couple of cushions and you instantly create a comfortable sofa. In the city, roof terraces are the most sought-after places. Whether you put a sunbed on a private terrace or beside the swimming pool on the top floor of a hotel, wouldn't it be great to be able to use the space it takes up in the evening as well? Sol+Luna, or sun and moon in Spanish, is a name that reflects the double purpose of this new piece of furniture, which can be used around the clock from your morning dip to the pool party after hours.



Back to  
index

---

It's a sofa ...

---

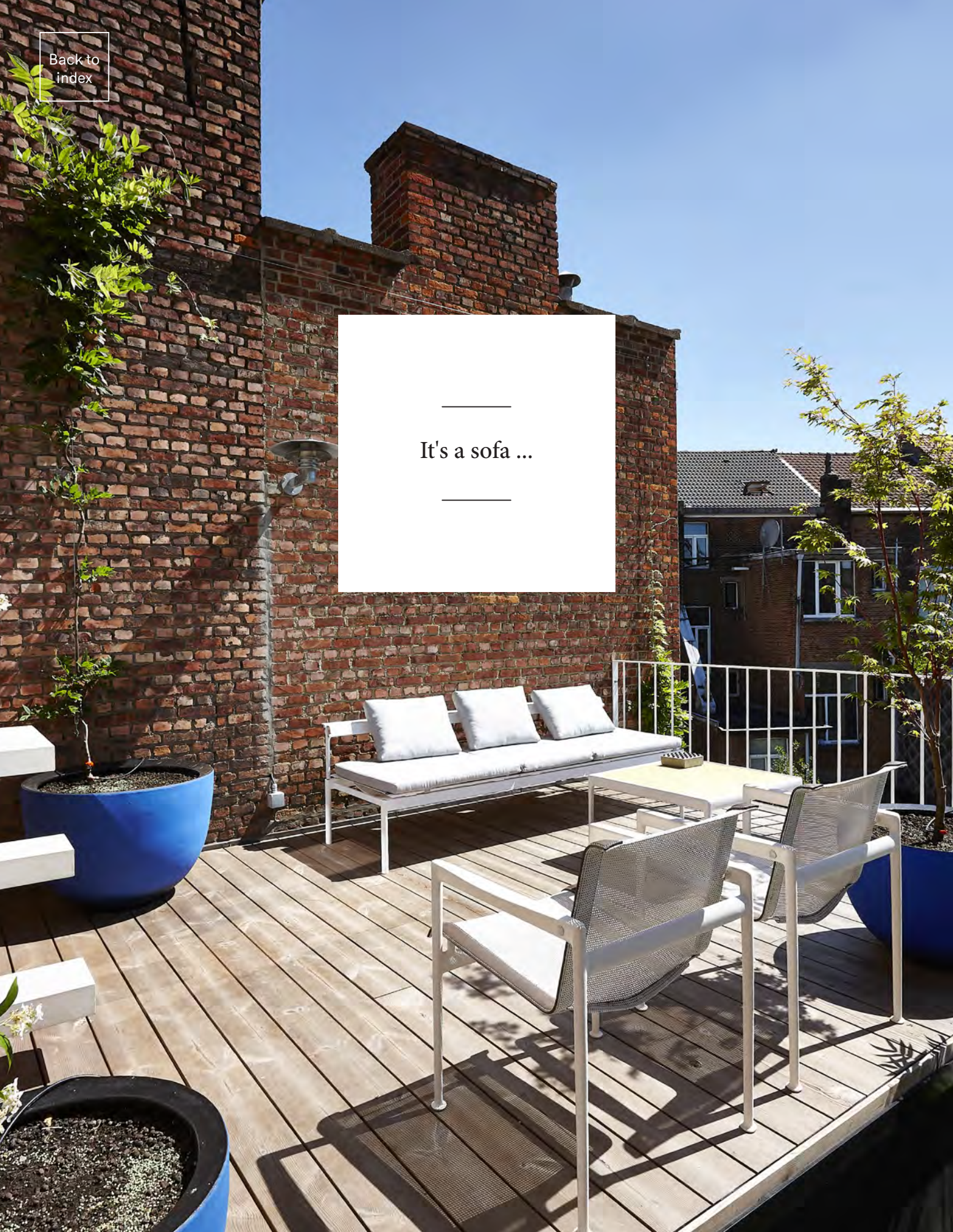



Sun **shade** or moon-shaped **lamp** in dimmable warm or cold light

**3 throw pillows** or a **large back cushion**

Seats 3 people

Plug-in **tapa table** for your drinks or food

**Storage net** for your towel or magazines

Collections

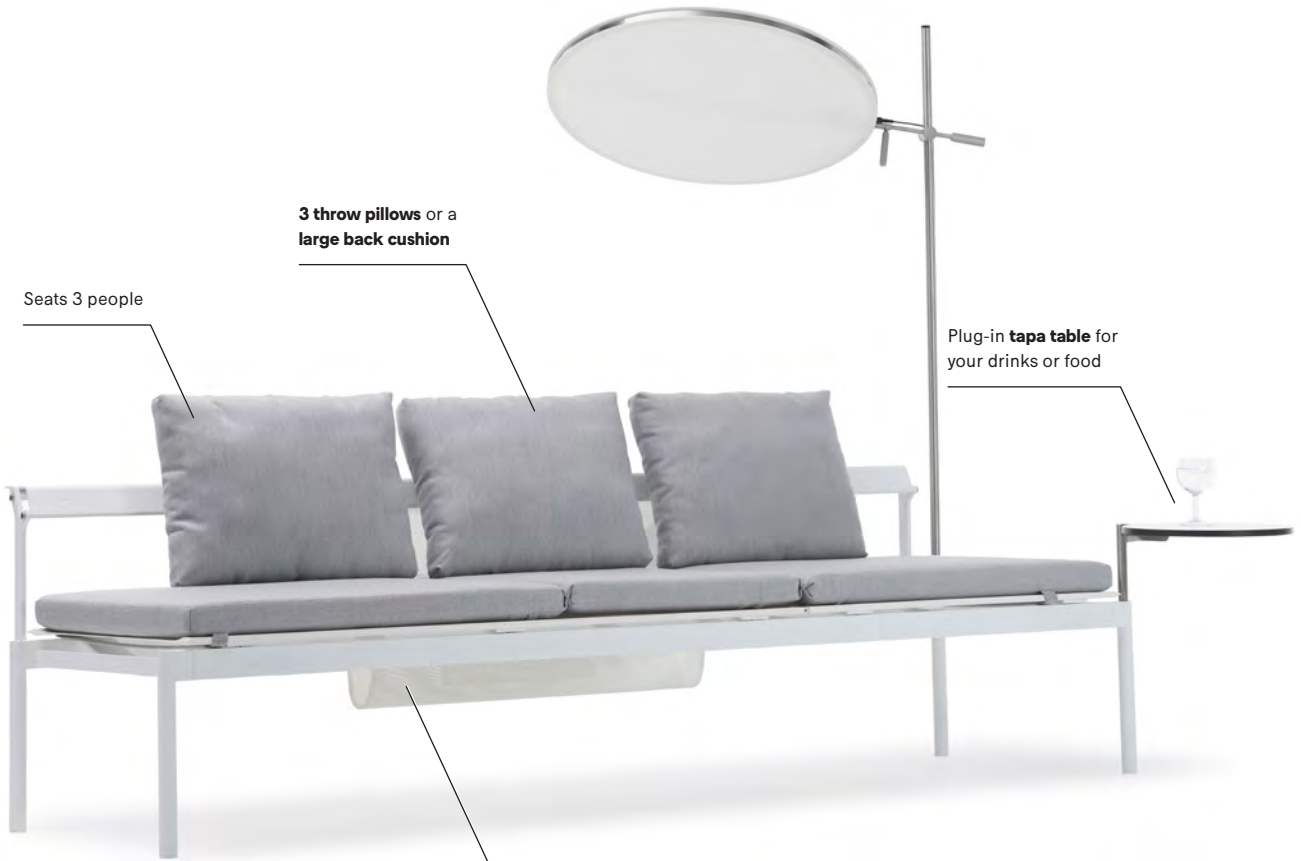

A designer **parasol** can easily be attached to the Sol+Luna and takes up minimal space, enabling you to read comfortably while the sun is out



A **locker** for your valuables while you're swimming

**Bolster pillow** or **throw pillow** to cradle your head while you're working on your tan

The **storage net** is very handy for safely stocking your towel or magazines

Handy **arm rest**

Extremis

**Linking table** to connect two sunbeds with each other, so you can lie down on your Sol+Luna sunbed at talking distance



**Multiple back rest positions** to give you ultimate comfort and relaxation during long summer days

The **recliner cushion** is made of Sunbrella, a soft-touch fabric that combines extra comfort with the best outdoor quality available; snugly strapped to the seat, which keeps it from being blown away by the wind

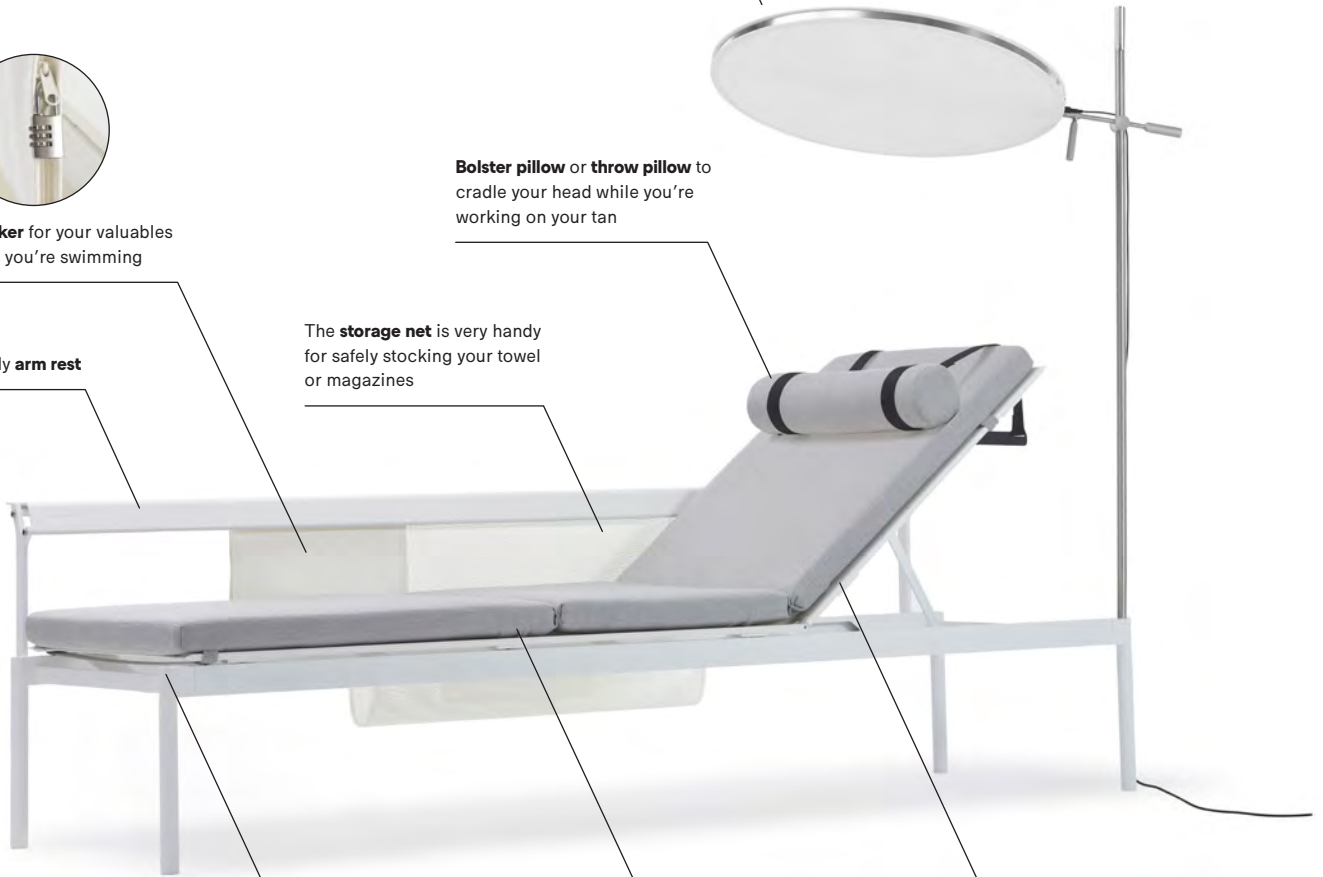

A modern outdoor pool area with lounge chairs, a brick wall, and a woman on stairs. The scene is set in a courtyard with a modern building on the left and a brick building in the background. The pool is filled with clear blue water, and the lounge chairs are arranged in a row. A woman in a floral dress is walking up a set of white stairs on the right side of the pool. The sky is blue with scattered white clouds.

—  
... and it's a sunbed.  
—

Back to  
index

The storage net is very handy for safely  
stocking your towel or magazines.

Extremis





Sol+Luna parasol with light protects you from the sun while reading, but also provides ambiance at night.



Back to  
index



---

## Borealis

---

Extremis



**Sol+Luna Borealis** has a somewhat more organic look perfect for rural environments, tropical resorts, cottage style gardens, ...



---

## Australis

---



Collections



**Sol+Luna Australis** has a clean and architectural look, perfect for modern buildings, urban environments, boutique hotels, design hotels, ...

Back to  
index

Extremis

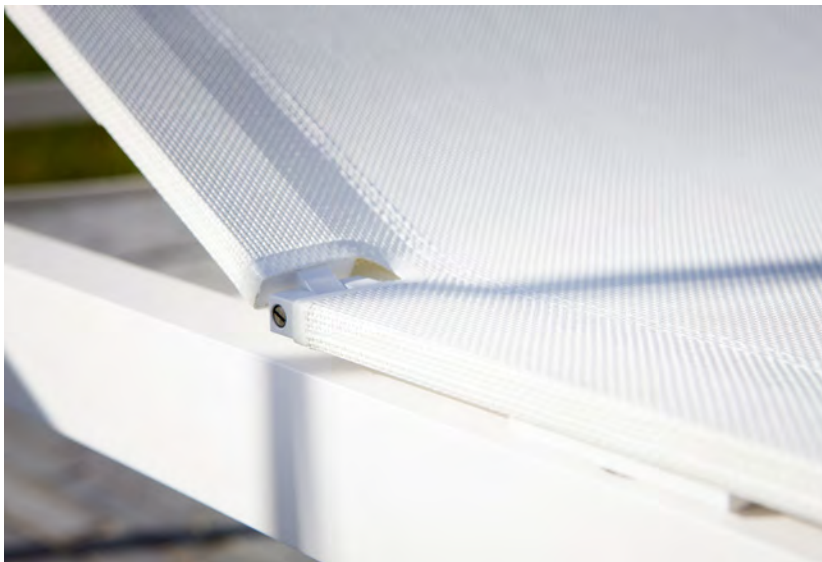





The Sol+Luna sunbeds invite you to take a plunge in the heated swimming pool of holiday home Acotée d'O.



A sun-drenched patio in Paarl,  
South-Africa.



Back to  
index



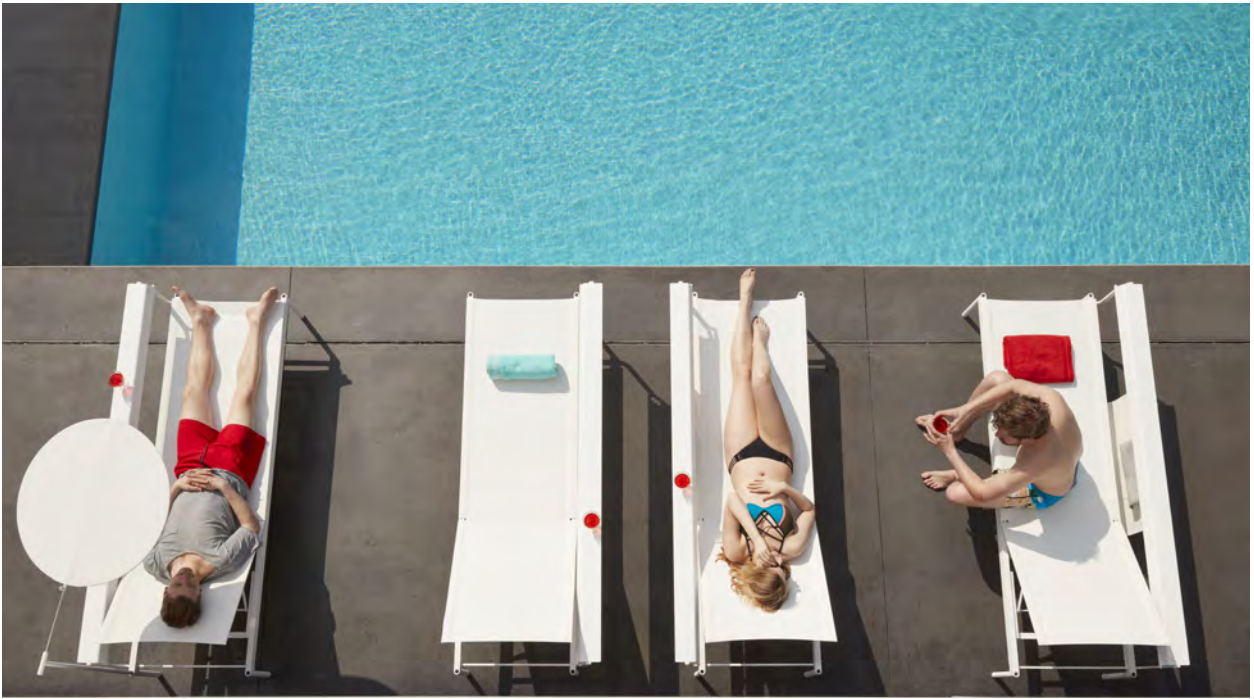

The perfect city centre patio to sunbathe, have a drink and chit chat with friends.

As the sun goes down, your friends drop by - great company,  
tapas and drinks - the perfect ingredients for a superb evening.

Extremis





Back to  
index

Extremis



A lazy day in the sun,  
relaxing and reading  
a book.





With Sol+Luna, it's never been easier to create an inviting place to relax in the evening. Even a petite balcony or porch can be transformed into a lounge area, such as this suite at Jardin Bohémien

Know more about  
Sol+Luna

Back to  
index





Back to  
index



# Icecube

## *The party box*

With Icecube, hosts don't need to wait on their guests or put up with people coming into their kitchen and raiding their fridge. Furthermore, the cool lighting effects get everyone in the party mood.

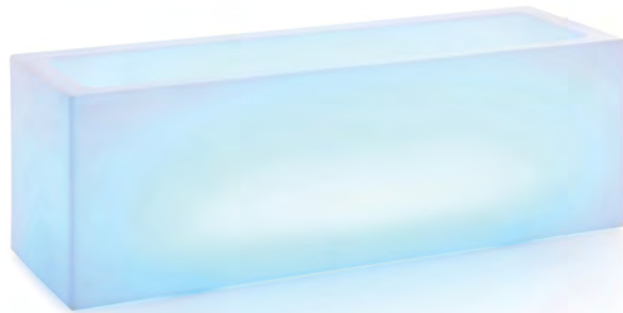



↑  
The perfect party tool for serving cool drinks. Optional lighting helps guests find the booze easily at night. Let your friends take their own drinks and treat them with togetherness.

→  
Icecube at Gelinaz! culinary event in Ghent, Belgium.

A white, illuminated tray containing several beer bottles on ice. The word "extremis" is printed in a bold, black, sans-serif font on the side of the tray. The scene is lit with a cool blue light, creating a high-contrast, modern aesthetic. The background is dark, making the white tray and the blue light stand out.

**extremis**

Know more about  
Icecube

## Extremis Headquarters Belgium

The Extremis headquarters in Poperinge, Belgium houses our passionate team, a fully operational production site, and an experimentation lab for design. There's also an inspiring showroom that offers guests an up-close and personal look at Extremis' classics and the latest contemporary designs.









### Extremis Germany

Our German showroom is situated at Design Post in Köln. We present our current trends in the historic halls of a former post office. It's an inspiring place for both end users who want to explore the new collections in a relaxing environment, and for retailers and architects who come to Design Post with clients and project owners to help them realise their plans.



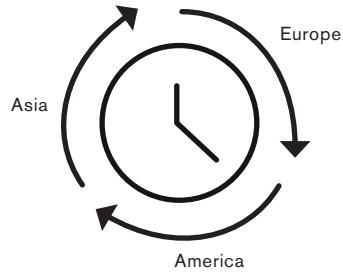

*You can find us all around the world,  
we are available 24 hours a day.*

**Extremis Japan**

At our Japanese showroom in Taito, Tokyo, Michiko and her team offer Extremis' full line of products and provide all tips and tricks in order to choose wisely. They inspire and share our expertise with the local market with this showroom, a great meeting place to discuss projects too.



**Extremis USA - The traveling showroom**

Our Extremis' enthusiasts Thomas and Ashlee are crossing the United States to preach the holy Extremis brand bible to the uninitiated. Okay, we're exaggerating... They just drive around in this branded van to every corner of the nation - from the gleaming skyscrapers of New York to star-saturated Hollywood - to showcase Extremis' products at various events and design shows.



They set up camp at the One Workplace event ONEder in San Francisco. Inspired by a common passion for design and creativity and fueled by curiosity, ONEder brought together the best designers and manufacturers in the world, where they were created to showcase the latest product offerings.

# Colophon

## EDITOR

Dirk Wynants Design Works  
info@dwdw.be

## WORDS

Brand Senses  
Com & Co  
Chris Meplon  
Studio Parys  
Dirk Wynants  
Marieke Hauspie  
Bram Coudijzer

## LAY-OUT

Chocolate Jesus  
Bram Coudijzer  
Ferre Verdonck

## COORDINATION

Dirk Wynants  
Cies Vanneste  
Bram Coudijzer

## PUBLISHER

Extremis – Hilde Louwagie  
hilde@extremis.be

## EXTREMIS

Couthoflaan 20b  
8972 Poperinge - BELGIUM  
+32 57 346020  
info@extremis.com  
www.extremis.com

## IMAGES

Abbas Almohri  
Alexander popelier  
Arne Jennard  
Beeldcollectief  
BOLD  
Chris Ford  
Extremis  
Francisco Garvi  
Hilde Verbeke  
Jan Verlinde  
Jelle Vandecasteele  
Joost Demuyncx  
Kasia Gatkowska photography  
Katsey.org  
Liestbeth Goetschalckx  
Lucas Despriet  
Luis Diaz Diaz  
Marc Wallican  
Michaël Depestele  
Mikael Linden  
Piet De Kersgieter  
Photographil  
Simone Vogel  
Studio Nunu  
Studio Pointu  
Tim Van De Velde  
Thomas Libiszewski  
Thomas 'Switn' Sweertvaegher  
Toon Grobet  
Verne

All rights reserved. Unless otherwise specified, all designs and photographs contained in this publication are copyright protected and are the property of Extremis. No part of this publication may be copied or distributed without Extremis' prior written consent. The names of the authors of photographs to which we do not hold rights are mentioned here. We have done our utmost to provide a comprehensive list of names. In the event of an alleged breach, please contact the editorial staff.

© Extremis

## BE THE FIRST TO KNOW

Facebook  
Linkedin  
Pinterest  
Instagram  
Vimeo



[WWW.EXTREMIS.COM](http://WWW.EXTREMIS.COM)

